

1.1

Check valve

Type S

Sizes 6 to 40
Up to 315 bar
Up to 600 L/min



Contents

Function and configuration	02
Ordering code	02
Technical data	03
Characteristic curves	03
Unit dimensions of threaded connection	04
Unit dimensions of sub-plate mounting	05

Features

- Poppet valve seat
- Threaded connection and sub-plate mounting
- Various cracking pressures, optional

Symbol

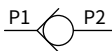

Function and configuration

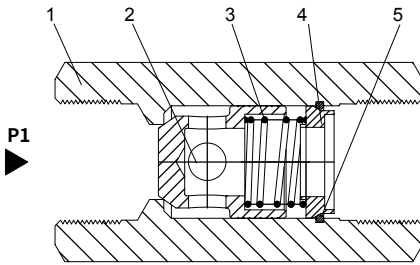

1. Housing
2. Poppet spool
3. Spring
4. Spring seat
5. Steel wire retaining ring

Check valve type S is used to allow fluid flowing in one direction and leakage-free closure in the opposite direction. When fluid flow via port P1, fluid pushes poppet (2) to move overcoming the spring(3), and connects chamber P1 and P2. When fluid flows from P2 to P1, poppet (2) moves left and the check valve closes.

For check valves without a spring, the fixed position should ensure that the poppet will remain at the closed position.

Ordering code

S									*
---	--	--	--	--	--	--	--	--	---

Check valve

Nominal sizes	Threaded connection	Sub-plate mounting
6	=6	
8	=8	
10	=10	=10
15	=15	
20	=20	=20
25	=25	
30	=30	=30
40	=40	

For threaded connection = A
For sub-plate mounting = P

Further details in clear text

Only for sub-plate mounting
No code = NBR seals
V = FKM seals

Only for threaded connection
No code= G thread
2= Metric thread
3= NPTF thread
(Not suitable for nominal size 15, 20 and 40)
4= SAE straight thread
(Not suitable for nominal size 40)

·0 = Threaded connection revision index
-L2X = Sub-plate mounting series L20 to L29
(L20 to L29: unchanged installation and connection dimensions)

0 = Without spring (Not for size 40)
1 = Crack pressure 0.5 bar
2 = Crack pressure 1.5bar
20= Crack pressure 2bar
3 = Crack pressure 3bar
40= Crack pressure 4bar
5 = Crack pressure 5bar

Technical data

Size		6	8	10	15	20	25	30	40
Max. flow-rate	L/min	15	30	40	120	200	300	400	600
Max. operating pressure	bar	315, 210 (NPTF1 1/4, NPTF1 1/2)							
Crack pressure	bar	0.5; 1.5; 2; 3; 4; 5							
Fluid		Mineral oil ; Phosphate ester							
Fluid temperature range	°C	-30 to +80							
Viscosity range	mm ² /s	2.8 to 500							
Degree of contamination		Maximum permissible degree of fluid contamination: Class 9. NAS 1638 or 20/18/15, ISO4406							

Characteristic curves (Measured at $\vartheta_{oil}=40^{\circ}\text{C} \pm 5^{\circ}\text{C}$, using HLP46)

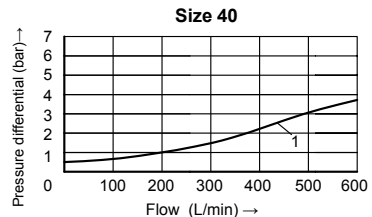
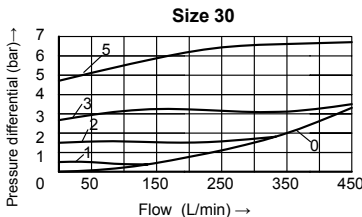
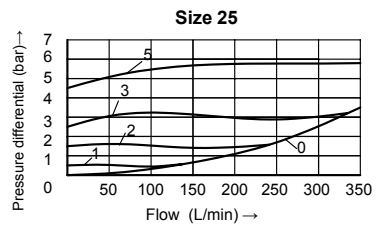
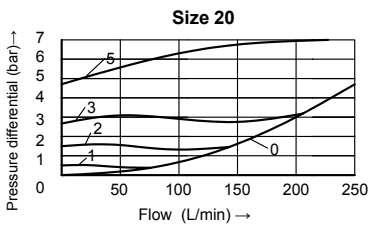
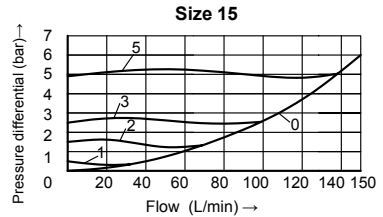
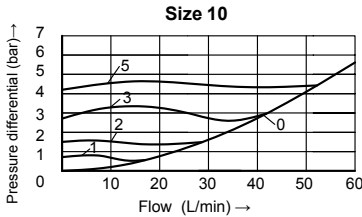
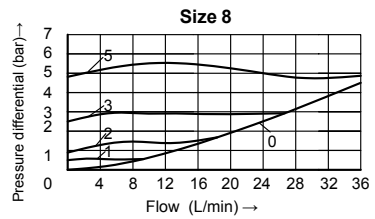
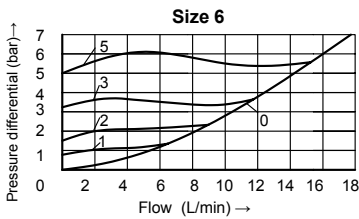

Unit dimensions of threaded connection

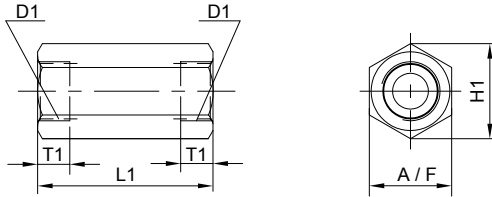

Size	6	8	10	15	20	25	30	40	
D1	G	G 1/4	G 3/8	G 1/2	G 3/4	G 1	G1 1/4	G1 1/2	G 2
	Metric	M14×1.5	M18×1.5	M22×1.5	M27×2	M33×2	M42×2	M48×2	M60×2
	NPTF	NPTF 1/4	NPTF 3/8	NPTF 1/2	—	—	NPTF 1 1/4	NPTF 1 1/2	—
	SAE	6SAE (9/16-18)	8SAE (3/4-16)	10SAE (7/8-14)	12SAE (1 1/16-12)	16SAE (1 5/16-12)	20SAE (1 5/8-12)	24SAE (1 7/8-12)	—
H1	22(SAE=28)	28(SAE=34.5)	34.5	41.5	53	69	75	92	
L1	58(SAE=68)	58(SAE=70)	72(SAE=85)	85(SAE=98)	98(SAE=108)	120 (SAE=130)	132(SAE=142)	165	
T1	12(SAE=14)	12(SAE=17)	14(SAE=20)	16(SAE=22)	18(SAE=22)	20 (SAE=22)	22(SAE=24)	28	
A/F	19(SAE=24)	24(SAE=30)	30	36	46	60	65	80	
Weight(kg)	0.1(SAE=0.23)	0.2(SAE=0.29)	0.3(SAE=0.35)	0.5(SAE=0.58)	1(SAE=1.1)	2(SAE=2.2)	2.5(SAE=2.7)	4.4	

Unit dimensions of sub-plate mounting

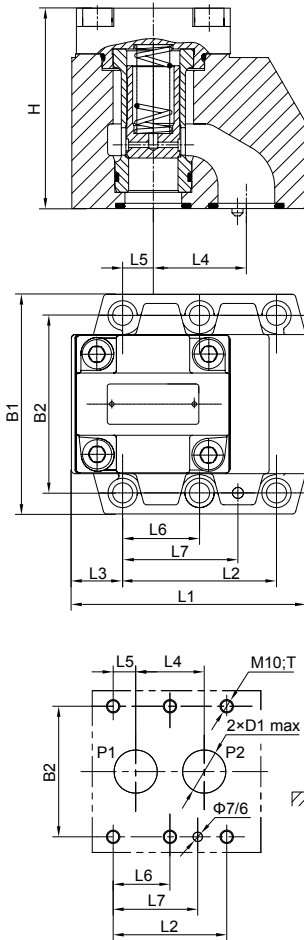

It must be ordered separately, if connection plate is needed.

Type:

Size 10:

- G460/01A (G3/8) G460/02(M18×1.5)
- G461/01A (G1/2) G461/02(M22×1.5)

Size 20:

- G412/01(G3/4) G412/02(M27×2)
- G413/01(G1) G413/02(M33×2)

Size 30:

- G414/01(G1 1/4) G414/02(M42×2)
- G415/01(G1 1/2) G415/02(M48×2)

Valve fixing screws:

- Size 10: 4-M10×40 GB/T 70.1-10.9
- Size 20: 4-M10×50 GB/T 70.1-10.9
- Size 30: 6-M10×60 GB/T 70.1-10.9

Size	B1	B2	L1	L2	L3	L4	L5	L6	L7	H	D1	T	O-ring	Weight(Kg)
10	85	66.7	78	42.9	18	28.6	7.2	-	31.8	71	Φ13	23	17.12×2.62	2
20	102	79.4	101	60.3	23	38.1	11.1	-	44.5	108	Φ22	24	28.17×3.53	4.3
30	120	96.8	128	84.2	28	50.8	16.7	42.1	62.7	110	Φ30	25	34.52×3.53	7.7

China

+86 400 101 8889

America

+01 630 995 3674

Germany

+49 172 3683463

Japan

+81 03 6809 1696



© This brochure can be reproduced, edited, reproduced or transmitted electronically without the authorization of Hengli Hydraulic Company. Due to the continuous development of the product, the information in this brochure is not specific to the specific conditions or applicability of the industry, thus, Hengli does not take any responsibility for any incomplete or inaccurate description.