

2-way cartridge valves -pressure control function

5.2

Cartridge valves Type L-LC.. Control covers Type L-LFA...

Nominal sizes 16 to 100

Series 6X, 7X

Maximum operating pressure 420 bar

Maximum flow-rate 7000 L/min



Contents

Description

Function, section and symbol	02-04
-General	02
-Pressure relief function	02
-Pressure reducing function	03
-Pressure sequencing function	04

1). Pressure relief valve function

-Cartridge valve Type L-LC.DB...	05-13
Ordering code	05
Symbols	06
Technical data	06
Characteristic curve	07-12
O-ring type	13

-Control cover Type L-LFA.DB...

14-40	
Technical data	14
O-rings for control oil ports	15
Fixing screw	15
Ordering code, symbols and unit dimension	
-Type DB	15-18
-Types DBW; DBS	19-23
-Type DBWD	24-26
-Types DBU2A; DBU2B	27-30
-Type DBU3D	31-35
-Type DBE	36
-Type DBEM	37-40

2). Pressure reducing valve function

-Cartridge valve Type L-LC.DR...	41-46
Ordering code	41
Symbols	42
Technical data	42
Characteristic curve	43-45
O-ring type	46

-Control cover Type L-LFA.DR.....

47-57	
Technical data	47
O-rings for control oil ports	48
Fixing screw	48
Main dimension	49
Ordering code, symbols and unit dimension	
-Type DR	50-51
-Type DRW	52-53
-Types DREV; DREZ	54-55
-Types DREWV; DREWZ	56-57

3). Pressure sequencing function

-Control cover Type L-LFA.DZ.....	58-64
Technical data	58-59
O-ring type	59
Fixing screw	59
Ordering code, symbols and unit dimension	
-Type DZ	60-61
-Type DZW	62-63

Function, section and symbol

• General

The 2-way cartridge valves for pressure control functions are pilot operated poppet or spool valves. The main component designed as a cartridge valve (1) is inserted in a hole bore standardized to DIN ISO 7368 and is sealed by control cover (2).

The pilot valve (4) is integrated into the control cover (2) or mounted onto the control cover as a pilot valve with interface connections to DIN 24 340 (2). Different pressure functions can be realized by combining the cartridge valve with the control covers.

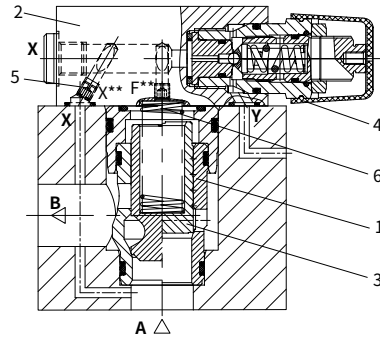

Type L-LC..DB..D... Type L-LC..DB..E...

05

• Pressure relief function

Control cover type L-LFA..DB...

Cartridge valve type L-LC..DB...

The cartridge valve (1) for the pressure relief function (type L-LC . DB...) is a poppet valve with a area ratio of 1:1 (no effective area at port B). The pressure acting at port A is fed via the pilot oil supplying orifice (5) to the main spring chamber (6). At pressures below the setting of pilot valve (4) the forces on spool (3) are balanced and the spool remains closed due to the spring force. On reaching the set pressure, spool (3) opens and limits the pressure at port A in line with the pressure-flow characteristics.

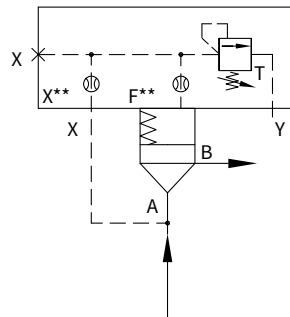

Type L-LFA..DB...

Type L-LC..DB...

Function, section and symbol

• Pressure reducing function

a) Normally open:

Control cover type L-LFA...DB...

Cartridge valve type L-LC..DR...

The cartridge valve for the pressure reducing function is a poppet valve with a area ratio of 1:1 (no effective area at port B), adopting the same types of cover (type LFA ..DB...) used as pilot valves which are used for the pressure relief functions.

The pressure fed via the pilot oil orifice is acting on the main spring chamber. When pressure is below the setting of pilot valve, the forces on spool are balanced and the spool remains open due to the spring force. Consequently, fluid flows port B to port A free. On reaching the set pressure, spool closes and reduces the pressure at port A in line with the pressure-flow characteristics.

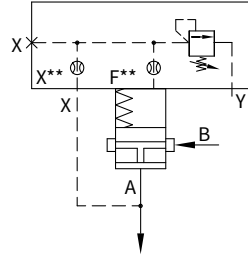

E.g. **Type L-LFA..DB...**
Type L-LC..DR40...

b) Normally closed:

Control cover type L-LFA...DR...

Cartridge valve type L-LC..DB...D...

For the pressure reducing function with opening characteristics, a pressure relief valve cartridge (type L-LC..DB..D...) and a control cover with a pressure reducing valve (type L-LFA..DR...) as the pilot valve are used. The pilot oil is fed from port A via the pilot orifice and the open pressure reducing valve to side B. The main spool opens and allows free flow from port A to port B. On reaching the setting pressure, the main spool closes and reduces the pressure at port B in line with the pressure-flow characteristics. If excess pressure occurs on the pressure reducing side, pressure relieves via the third port of the pilot valve. By fitting a directional valve, an additional isolating function can also be attained (type L-LFA..DRW...).

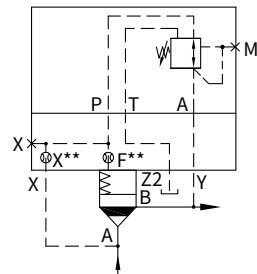

E.g. **Type L-LFA..DR...**
Type L-LC..DB40D...

Function, section and symbol

· Pressure sequencing function

Control cover type LFA..DZ...

Cartridge valve type LC..DB...

This function enables a pressure-dependent sequencing of a second system.

The required sequencing pressure is set by the pilot valve which is integrated into the control cover. The pilot oil supply may be either external (pilot oil port X) or internal (from port A via pilot oil port X or Z2).

The spring chamber of the pilot control is drained at zero pressure via ports Y or Z1 to tank.

When the pressure set at the pilot control spring is reached, the pilot valve switches and unloads the spring chamber of the main valve to tank. The main spool opens and makes the connection from port A to B possible.

In version LFA..DZW..., the required spool position may be selected by means of an electrically operated pilot valve (not included with the scope of control cover LFA..DZW... supply) in addition to the normal hydraulic control.

Circuit examples

Example 1:

(circuit for the pressure dependent unloading of the low pressure system)

In the circuit shown, the system is fed by a high pressure pump and a low pressure pump. The system pressure PS acts externally from the high pressure side via the pilot oil port X on the pilot valve which, on reaching the set pressure, switches the low pressure side to give zero pressure circulation. The check valve RV (not included within the scope of supply) prevents the high pressure system from flowing into the low pressure system which is now at zero pressure.

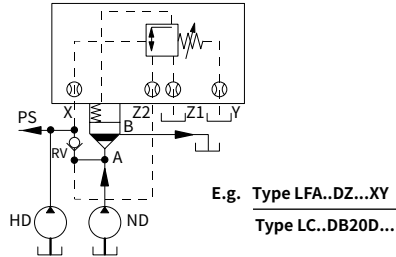

Example 2: (circuit for the pressure dependent sequencing of a 2nd system)

With this circuit, oil is allowed to flow into system 2 when the pressure in system 1 has reached a pre-set value. The pilot oil supply is internal from port A of the main valve.

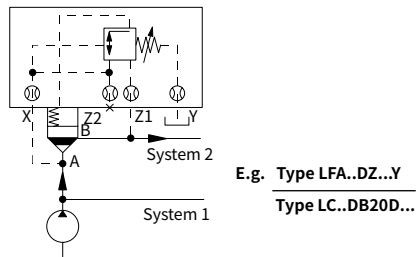

2-way cartridge valves -pressure control function

5.2-1(1)

Pressure relief valve function

Cartridge valve Type L-LC.DB...

Ordering code

- Pressure relief cartridge valve (without associated control cover)

L-LC		DB		— / —		*		
Cartridge valves							Further details in clear text	
Nominal size 16	= 16						No code = NBR seals	
Nominal size 25	= 25						V = FKM seals (Other seals, please consult us!)	
Nominal size 32	= 32						Caution: The harmony of seals and fluid must be taken into account.	
Nominal size 40	= 40							
Nominal size 50	= 50							
Nominal size 63	= 63							
Nominal size 80	= 80							
Nominal size 100	= 100							
Relief function								
Cracking pressure approx. 0 bar (without spring) = 00								
Cracking pressure approx. 2 bar = 20								
Cracking pressure approx. 3 bar = 30								
Cracking pressure approx. 4 bar = 40								
Cracking pressure approx. 5 bar = 50 ¹⁾								
Cracking pressure approx. 8 bar = 80 ²⁾								
								7X (NG 16 to 63) = Series 70 to 79 (70 to 79: unchanged installation and connection dimensions)
								6X (NG 80 and 100) = Series 60 to 69 (60 to 69: unchanged installation and connection dimensions)
								E = Poppet valve without orifice (standard)
								D = Spool poppet valve without damping nose
								A = Poppet valve with damping nose
								B = Spool poppet valve with damping nose

¹⁾ Only for size 16, 25 and 32.

²⁾ Special installation space is required.

Symbols

Cartridge valves (for versions see Ordering code)

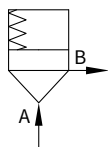

Poppet without damping nose version "E"

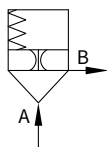

Poppet with damping nose version "A"

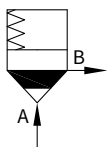

Spool poppet without damping nose version "D"

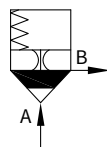

Spool poppet without damping nose version "B"

Technical data

Fluid		Mineral oil suitable for NBR and FKM seal Phosphate ester for FKM seal								
Fluid temperature range		°C	-30 to +80 (NBR seal) -20 to +80(FKM seal)							
Viscosity range		mm ² /s	2.8 to 380							
Degree of contamination		Maximum permissible degree of fluid contamination: Class 9. NAS 1638 or 20/18/15 , ISO4406 ¹⁾								
2-way cartridge valve										
Max. operating pressure – Ports A and B		bar	420							
Max. flow-rate (recommendation)	Size		16	25	32	40	50	63	80	100
	Poppet valve cartridge "E" and "A"	L/min	300	450	600	1000	1600	2500	4500	7000
	Spool valve cartridge "D" and "B"	L/min	175	300	450	700	1400	1750	3200	4900

¹⁾ To prevent the problem caused by fluid contamination, fluid cleanliness mentioned above must be met.

For applications outside these parameters, please consult us!

Characteristic curves (Measured at $\vartheta_{oil}=40^{\circ}C \pm 5^{\circ}C$, using HLP46)

Nominal size 16

The characteristic curves were measured when an external pilot oil drains at zero pressure. when an internal pilot oil drains, the inlet pressure is increased along with the pressure at port B.

• Manual pressure adjustment: type L-LFA 16 DB... and type L-LFA 16 DBW...

Type L-LC 16 DB..E... (with poppet valve)

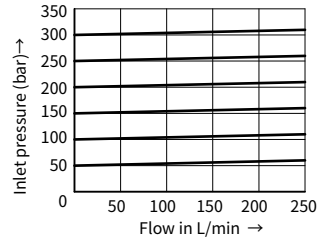
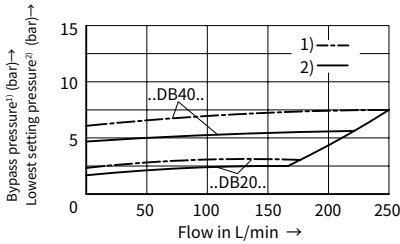

Type L-LC 16 DB..D... (with spool poppet valve)

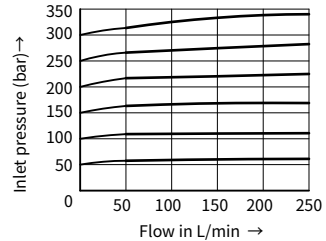
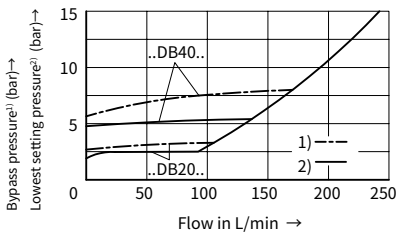

• Electrical proportional pressure adjustment: type L-LFA 16 DBE ...

Type L-LC 16 DB..E... (with poppet valve)

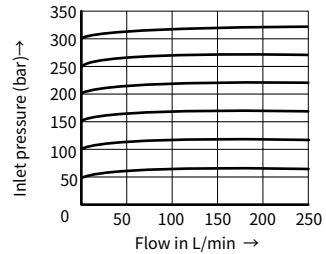
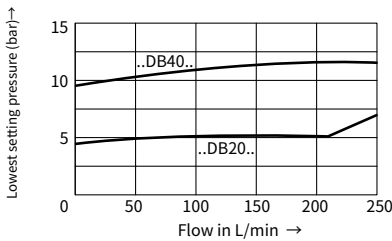

Type L-LC 16 DB..D... (with spool poppet valve)

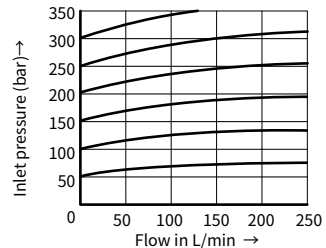
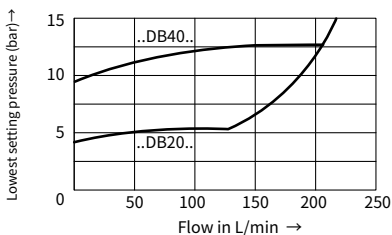

Characteristic curves (Measured at $\vartheta_{oil}=40^{\circ}C \pm 5^{\circ}C$, using HLP46)

Nominal size 25

The characteristic curves were measured when an external pilot oil drains at zero pressure. when an internal pilot oil drains, the inlet pressure is increased along with the pressure at port B.

· Manual pressure adjustment: type L-LFA 25 DB... and type L-LFA 25 DBW...

Type L-LC 25 DB..E... (with poppet valve)

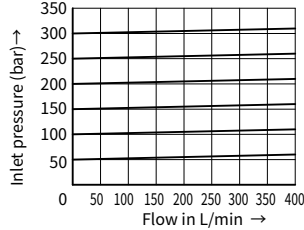
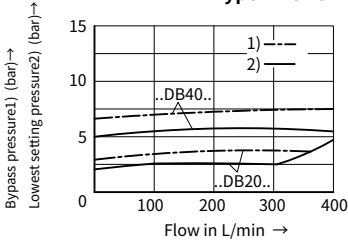

Type L-LC 25 DB..D... (with spool poppet valve)

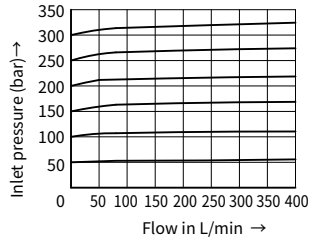
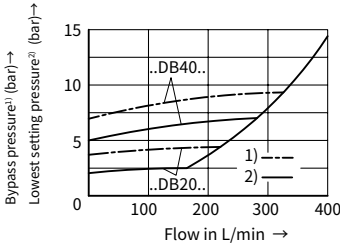

· Electrical proportional pressure adjustment: type L-LFA 25 DBE ...

Type L-LC 25 DB..E... (with poppet valve)

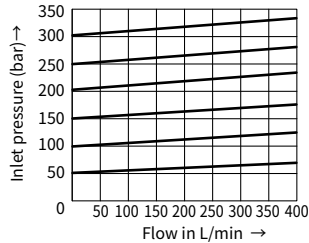
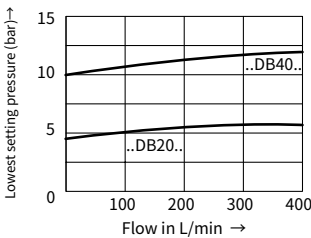

Type L-LC 25 DB..D... (with spool poppet valve)

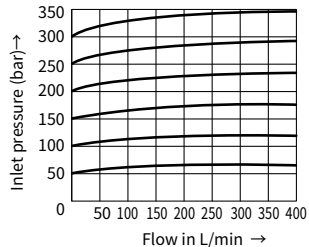
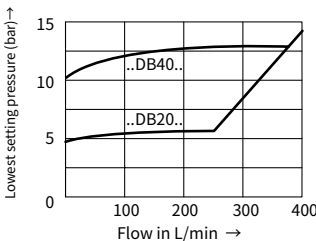

Characteristic curves (Measured at $\vartheta_{oil}=40^{\circ}C \pm 5^{\circ}C$, using HLP46)

Nominal size 32

The characteristic curves were measured when an external pilot oil drains at zero pressure. when an internal pilot oil drains, the inlet pressure is increased along with the pressure at port B.

• Manual pressure adjustment: type L-LFA 32 DB...and type L-LFA 32 DBW...

Type L-LC 32 DB..E... (with poppet valve)

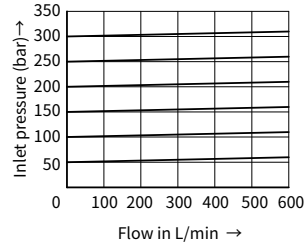
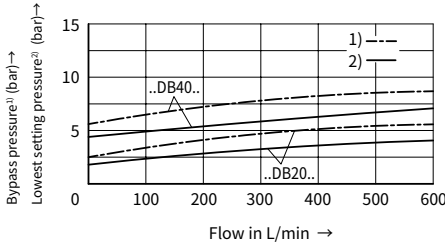

Type L-LC 32 DB..D... (with spool poppet valve)

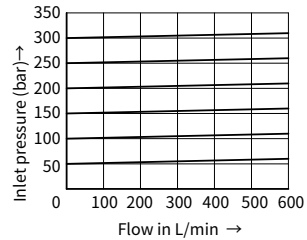
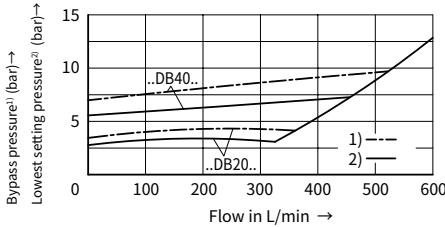

• Electrical proportional pressure adjustment: type L-LFA 32 DBE ...

Type L-LC 32 DB..E... (with poppet valve)

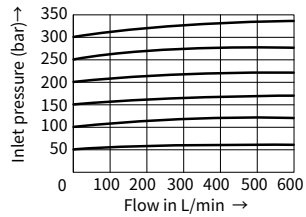
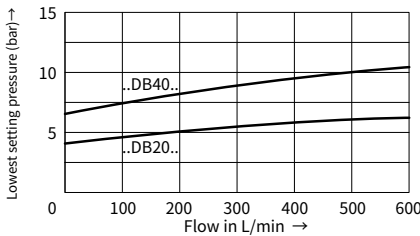

Type L-LC 32 DB..D... (with spool poppet valve)

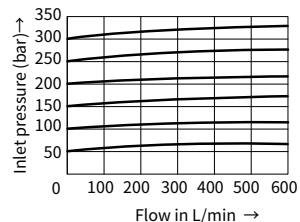
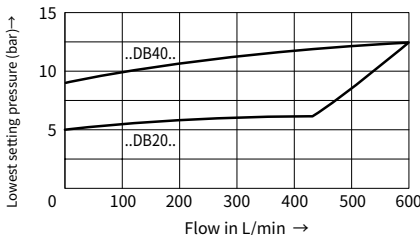

05

Characteristic curves (Measured at $\vartheta_{oil}=40^{\circ}C \pm 5^{\circ}C$, using HLP46)

Nominal size 40

The characteristic curves were measured when an external pilot oil drains at zero pressure. when an internal pilot oil drains, the inlet pressure is increased along with the pressure at port B.

• **Manual pressure adjustment: type L-LFA 40 DB... and type L-LFA 40 DBW...**

Type L-LC 40 DB..E... (with poppet valve)

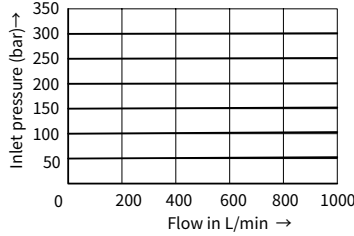
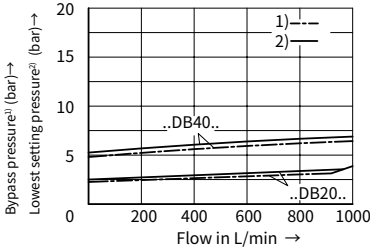

Type L-LC 40 DB..D... (with spool poppet valve)

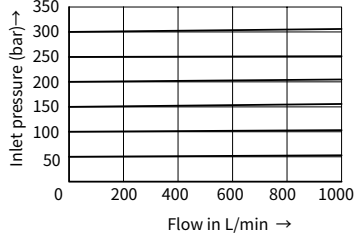
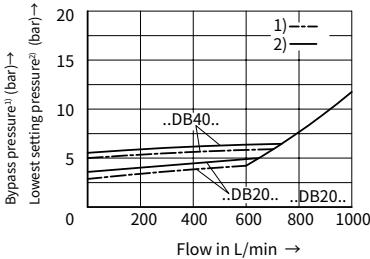

• **Electrical proportional pressure adjustment: type L-LFA 40 DBE ...**

Type L-LC 40 DB..E... (with poppet valve)

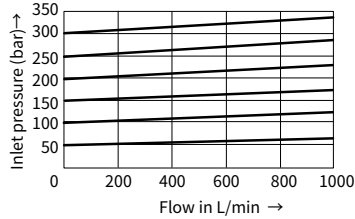
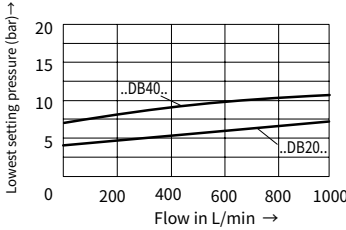

Type L-LC 40 DB..D... (with spool poppet valve)

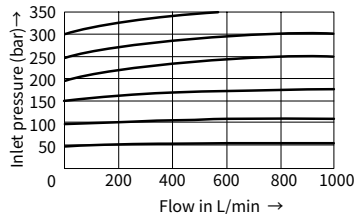
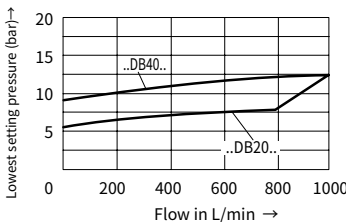

Characteristic curves (Measured at $\vartheta_{oil}=40^{\circ}C \pm 5^{\circ}C$, using HLP46)

Nominal size 50

The characteristic curves were measured when an external pilot oil drains at zero pressure. when an internal pilot oil drains, the inlet pressure is increased along with the pressure at port B.

Manual pressure adjustment: Type L-LFA 50 DB...and Type L-LFA 50 DBW...

Type L-LC 50 DB..E... (with poppet valve)

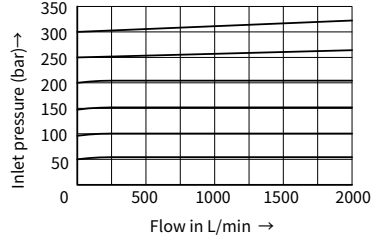
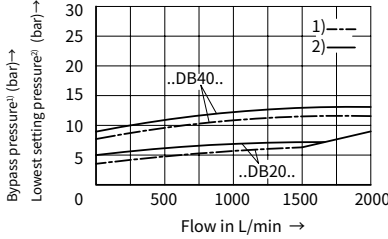

Type L-LC 50 DB..D... (with spool poppet valve)

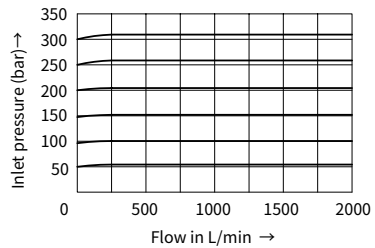
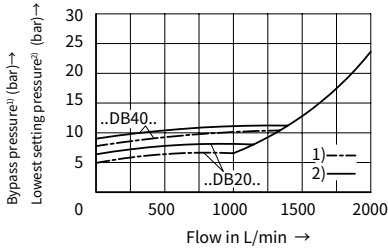

Electrical proportional pressure adjustment: type L-LFA 50 DBE ...

Type L-LC 50 DB..E... (with poppet valve)

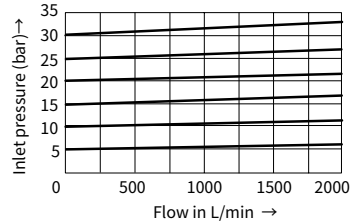
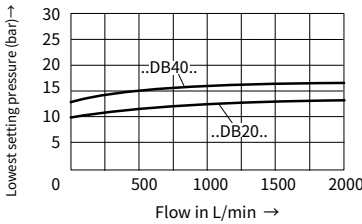

Type L-LC 50 DB..D... (with spool poppet valve)

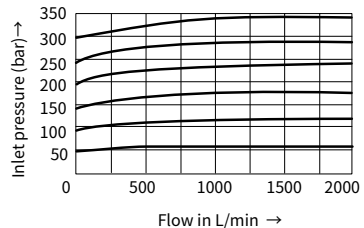
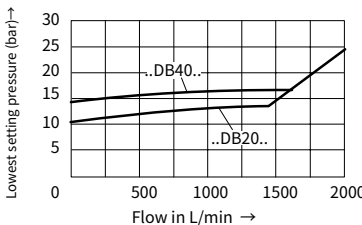

05

Characteristic curves (Measured at $\vartheta_{oil}=40^{\circ}C \pm 5^{\circ}C$, using HLP46)

Nominal size 63

The characteristic curves were measured when an external pilot oil drains at zero pressure. when an internal pilot oil drains, the inlet pressure is increased along with the pressure at port B.

• **Manual pressure adjustment: type L-LFA 63 DB... and type L-LFA 63 DBW...**

Type L-LC 63 DB..E... (with poppet valve)

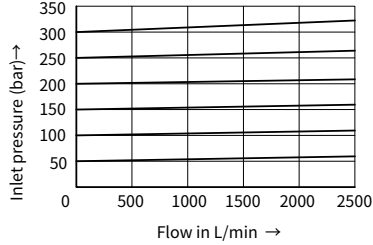
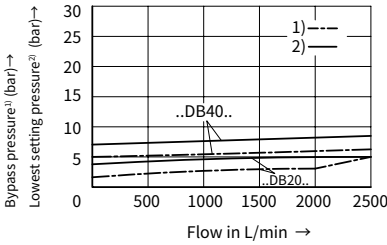

Type L-LC 63 DB..D... (with spool poppet valve)

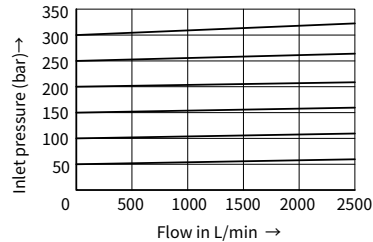
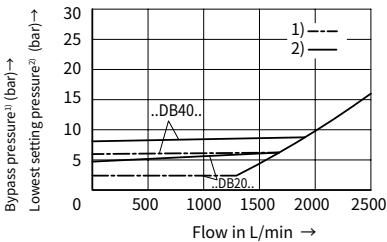

• **Electrical proportional pressure adjustment: type L-LFA 63 DBE ...**

Type L-LC 63 DB..E... (with poppet valve)

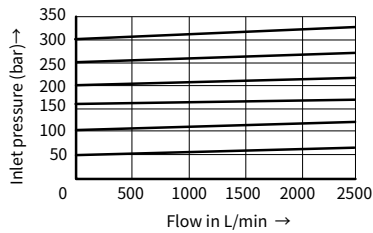
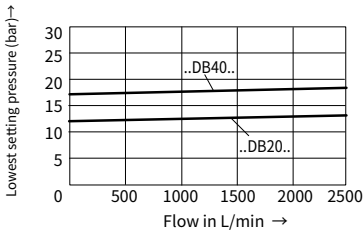

Type L-LC 63 DB..D... (with spool poppet valve)

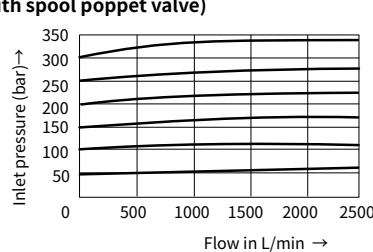
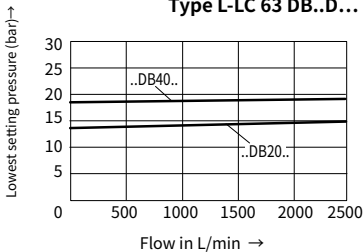

O-rings dimensions for type L-LC

• Nominal sizes 16, 25 and 32

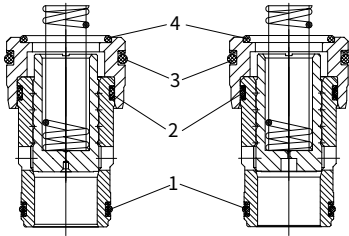

L-LC..DB..E...

L-LC..DB..A...

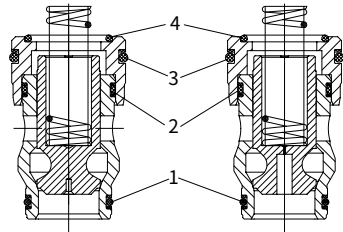

L-LC..DB..D...

L-LC..DB..B...

O-rings	No.	Nominal size		
		16	25	32
	1	21.2×1.8	28×2.65	40×2.65
	2	22.4×2.65	32.5×2.65	43.7×3.55
	3	26.5×2.65	38.7×3.55	54.5×3.55
	4	20×2.65	30×2.65	37.5×3.55

• Nominal sizes 40, 50 and 63

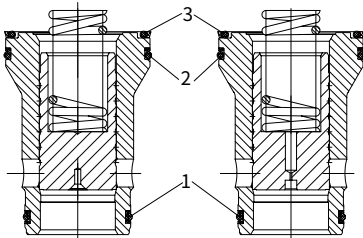

L-LC..DB..E...

L-LC..DB..A...

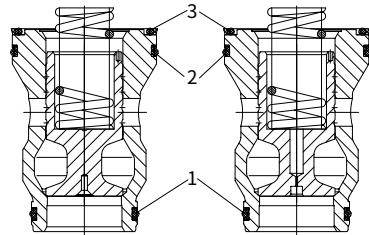

L-LC..DB..D...

L-LC..DB..B...

O-rings	No.	Nominal size		
		40	50	63
	1	48.7×3.55	61.5×3.55	80×5.3
	2	69×3.55	80×5.3	109×5.3
	3	67×3.55	77.5×5.3	106×5.3

2-way cartridge valves -pressure control function

5.2-1(2)

Pressure relief valve function

Control covers Type L-LFA.DB...

Technical data (Max. operating pressure of pilot control valve)

	Control cover		Max. operating pressure Y,T bar			Remark
	Size	Type	X	pressure limitation	Static	
DBD.2K-L20/... ¹⁾	16 to 32	DB,DBW,DBWD, DBU2.,DBBU3D, DBEM,DBS	420	Zero pressure (about to 2 bar)	315	Supply included
DBD.6K10/... ²⁾	40 to 63		400		315	
.WE6...			350		21(=); 16(~)	Order seperately

¹⁾ Possible pressure: 25, 50, 100, 200, 315, 400²⁾ Possible pressure: 25, 50, 100, 200, 315, 420

Technical data (Type L-LFA.DB..., for applications outside these parameters, please consult us!)

Max.operating pressure	bar	420	Caution: the max. operating pressure Pmax of pilot valve should be taken into account.
Fluid		Mineral oil suitable for NBR and FKM seal	
		Phosphate ester for FKM seal	
Fluid temperature range	°C	-30 to +80 (NBR seal)	
		-20 to +80 (FKM seal)	
Viscosity range	mm ² /s	2.8 to 380	
Degree of contamination		Maximum permissible degree of fluid contamination: Class 9. NAS 1638 or 20/18/15 , ISO4406 ³⁾	

³⁾ To prevent the problem caused by fluid contamination, fluid cleanliness mentioned above must be met.

O-rings dimensions for ports X, Y (included within the scope of supply)

Size	Dimension mm
16	8×1.8
25	9.25×1.78
32	10.82×1.78

Size	Dimension mm
40	12×2.5
50	
63	18.72×2.62

Mounting screw (included within the scope of supply)

In accordance with GB/T70.1 10.9			
Nominal size	QTY	Dimension	Tightening torque (Nm)
16	4	M8×45	32
25		M12×50	110
32		M16×60	270
40		M20×70	520

In accordance with GB/T70.1 10.9			
Nominal size	QTY	Dimension	Tightening torque (Nm)
50	4	M20×80	520
63		M30×100	1800
80		M24×120	900
100		M30×120	1800

Control cover with manual pressure adjustment (Dimensions in mm)

• Types ..DB... (Nominal sizes 16 to 100)

L-LFA		DB	- 7X															
Control cover																		
Nominal size 16	= 16			No code= NBR seals V = FKM seals (Other seals, please consult us!) Caution: The harmony of seals and fluid must be taken into account.														
Nominal size 25	= 25																	
Nominal size 32	= 32																	
Nominal size 40	= 40																	
Nominal size 50	= 50																	
Nominal size 63	= 63																	
Nominal size 80	= 80																	
Nominal size 100	= 100																	
Control covers version																		
Rotary knob	=1																	
Hexagon waith protective c	=2																	
Lockable rotary knob with scale (H-key to automotive industry standards)	=3																	
Rotary knob with scale	=4																	
Series 60 to 69 (NG80 and NG100)	=6X			Pressure ratings <table border="1"> <thead> <tr> <th>Sizes 16, 25 and 32</th> <th>Sizes 40, 50, 63, 80 and 100</th> </tr> </thead> <tbody> <tr> <td>025 = 25 bar</td> <td>025 = 25 bar</td> </tr> <tr> <td>050 = 50 bar</td> <td>050 = 50 bar</td> </tr> <tr> <td>100 = 100 bar</td> <td>100 = 100 bar</td> </tr> <tr> <td>200 = 200 bar</td> <td>200 = 200 bar</td> </tr> <tr> <td>315 = 315 bar</td> <td>315 = 315 bar</td> </tr> <tr> <td>420 = 420 bar</td> <td>400 = 400 bar</td> </tr> </tbody> </table>	Sizes 16, 25 and 32	Sizes 40, 50, 63, 80 and 100	025 = 25 bar	025 = 25 bar	050 = 50 bar	050 = 50 bar	100 = 100 bar	100 = 100 bar	200 = 200 bar	200 = 200 bar	315 = 315 bar	315 = 315 bar	420 = 420 bar	400 = 400 bar
Sizes 16, 25 and 32	Sizes 40, 50, 63, 80 and 100																	
025 = 25 bar	025 = 25 bar																	
050 = 50 bar	050 = 50 bar																	
100 = 100 bar	100 = 100 bar																	
200 = 200 bar	200 = 200 bar																	
315 = 315 bar	315 = 315 bar																	
420 = 420 bar	400 = 400 bar																	
(60 to 69: unchanged installation and connection dimensions)																		
Series 70 to 79 (NG16 to NG63)	=7X																	
(70 to 79: unchanged installation and connection dimensions)																		

Control cover with manual pressure adjustment

(Dimensions in mm)

• Types ..DB... (Nominal sizes 16, 25 and 32)

L-FA..DB..- 7X/..
 Sizes 16, 25 and 32

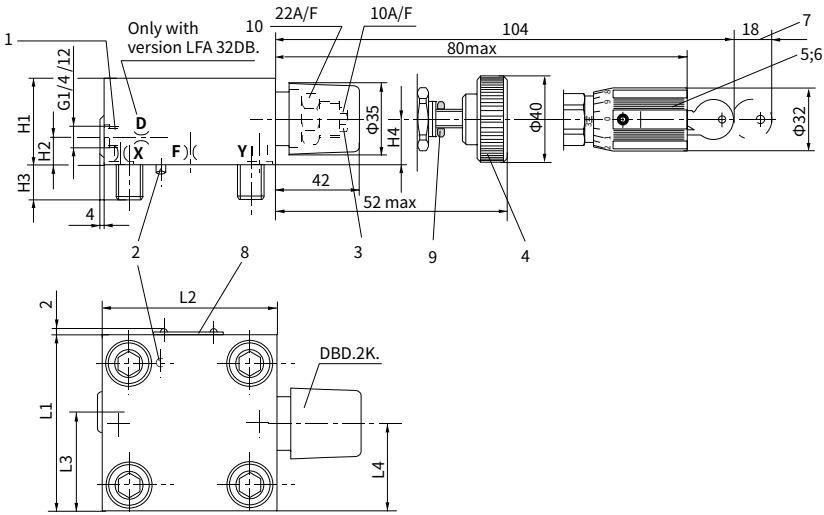
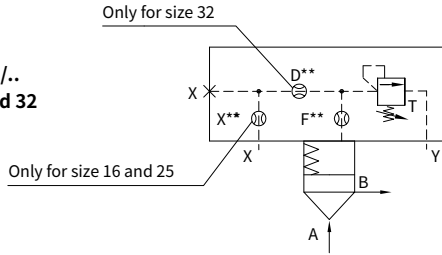

NG	16	25	32
H1	40	40	50
H2	17	19	26
H3	15	24	28
H4	19	19	26
L1	65	85	100
L2	80	85	100
L3	36.5	49	56.5
L4	32.5	45.5	53
Weight Kg	1.7	2.1	3.8

- 1 Port X optionally as threaded port
- 2 Locating pin
- 3 Adjustment type "2"
- 4 Adjustment type "1"
- 5 Adjustment type "3"
- 6 Adjustment type "4"
- 7 Space required to remove the key
- 8 Name plate
- 9 Locknut

Control cover with manual pressure adjustment

(Dimensions in mm)

• Types ..DB... (Nominal sizes 40, 50 and 63)

Nominal size 40 and 50

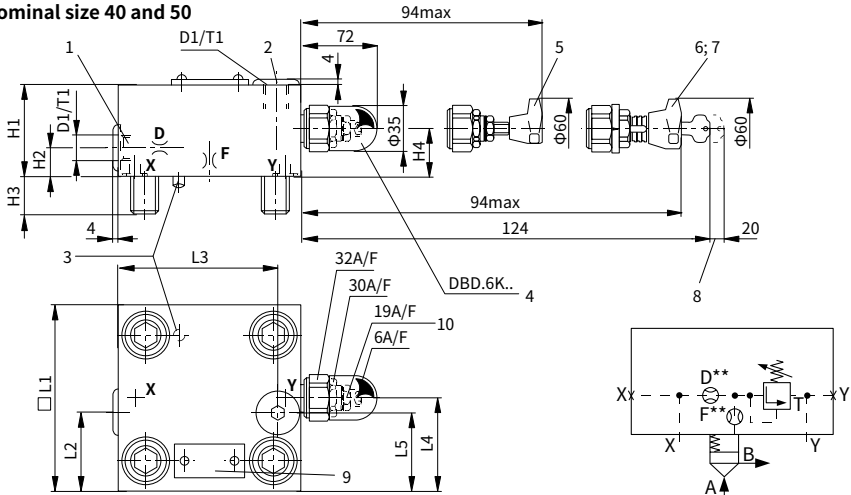

LFA..DB.-7X/..
Sizes 40, 50, 63

Nominal size 63

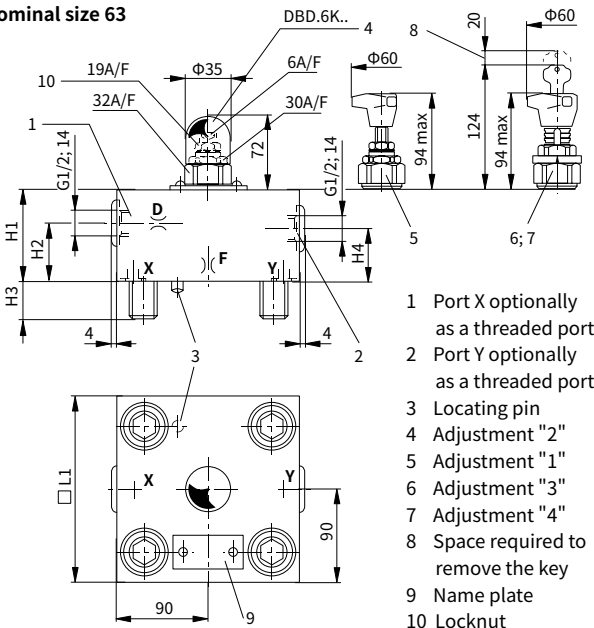

- 1 Port X optionally as a threaded port
- 2 Port Y optionally as a threaded port
- 3 Locating pin
- 4 Adjustment "2"
- 5 Adjustment "1"
- 6 Adjustment "3"
- 7 Adjustment "4"
- 8 Space required to remove the key
- 9 Name plate
- 10 Locknut

NG	40	50	63
D1	G1/4	G1/2	
H1	60	68	82
H2	28	19.5	30
H3	32	34	50
H4	27	35	50
□ L1	125	140	180
L2	69	80	
L3	89	105	
L4	76	84	
L5	60	70	
T1	12	14	
Weight Kg	6.8	9.6	18.9

Control cover with manual pressure adjustment

(Dimensions in mm)

· Types ..DB... (Nominal sizes 80 and 100)

LFA...DB.-6X/...
Sizes 80 and 100

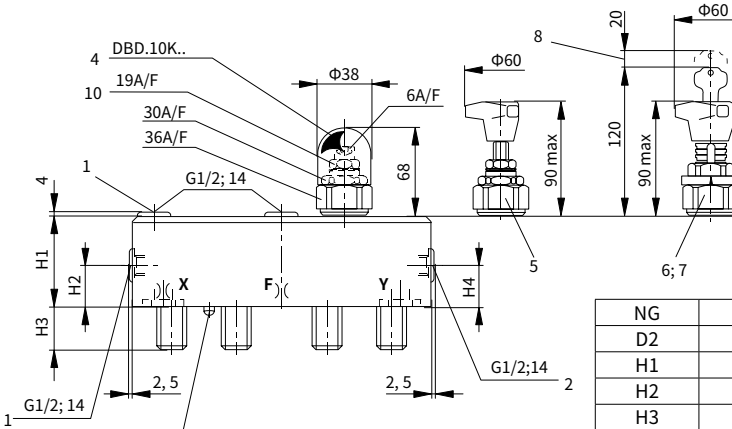
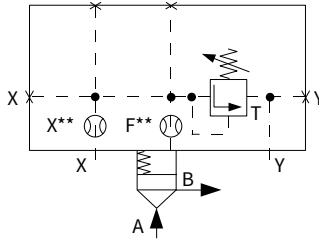

NG	80	100
D2	250	300
H1	100	100
H2	38	38
H3	45	51
H4	58	58
L8	50	50

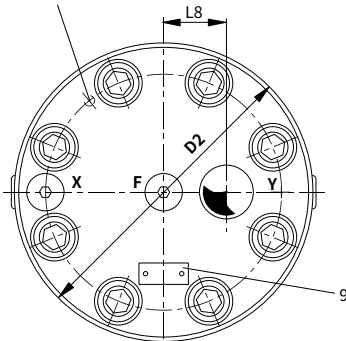

- 1 Port X optionally as a threaded port
- 2 Port Y optionally as a threaded port
- 3 Locating pin
- 4 Adjustment type "2"
- 5 Adjustment type "1"
- 6 Adjustment type "3"
- 7 Adjustment type "4"
- 8 Space required to remove the key
- 9 Name plate
- 10 Locknut

Control cover with manual pressure adjustment, with electrical unloading function

• Types ..DBW...; ..DBS... (Nominal sizes 16 to 100)

L-LFA						7X	
Control cover							
Nominal size 16	=	16					
Nominal size 25	=	25					
Nominal size 32	=	32					
Nominal size 40	=	40					
Nominal size 50	=	50					
Nominal size 63	=	63					
Nominal size 80	=	80					
Nominal size 100	=	100					
Control covers version							
For mounting surfaces a	=	DBW					
Directional spool valve (only for sizes 16 to 100) or directional poppet valve (only for sizes 16, 25, 32)	=	DBS					
For directional poppet valv (only for sizes 40, 50, 63, 80 and 100)							
Rotary knob	=	1					
Hexagon waith protective c	=	2					
Lockable rotary knob with scale (H-key to automotive industry standards)	=	3					
Rotary knob with scale	=	4					

No code= NBR seals
 V = FKM seals
 (Other seals, please consult us!)
Caution:
 The harmony of seals and fluid must be taken into account.

Pressure ratings
 (Max. permissible pressure of pilot valve must be taken into account)

Sizes 16, 25 and 32	Sizes 40, 50, 63, 80 and 100
025 = 25 bar	025 = 25 bar
050 = 50 bar	050 = 50 bar
100 = 100 bar	100 = 100 bar
200 = 200 bar	200 = 200 bar
315 = 315 bar	315 = 315 bar
420 = 420 bar	400 = 400 bar

6X= Series 60 to 69 (NG80 and NG100)
 (60 to 69: unchanged installation and connection dimensions)
 7X= Series 70 to 79 (NG16 to NG63)
 (70 to 79: unchanged installation and connection dimensions)

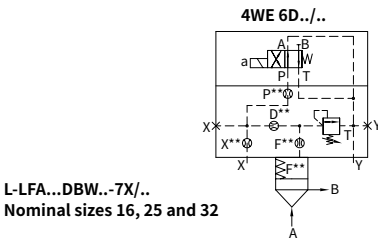

L-LFA...DBW..-7X/..
 Nominal sizes 16, 25 and 32

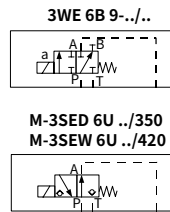

M-3SED 6U ../350
 M-3SEW 6U ../420

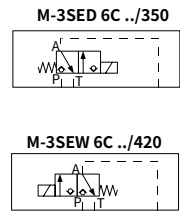

M-3SEW 6C ../420

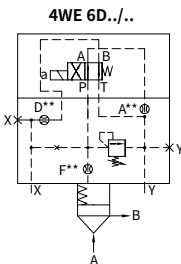

L-LFA...DBW..-7X/..
 Nominal sizes 40, 50 and 63

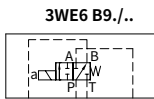

3WE 6B 9/..

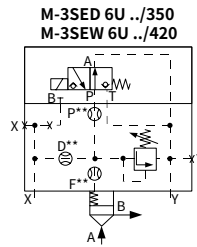

L-LFA..DBS..-7X/..
 Nominal sizes 40, 50 and 63

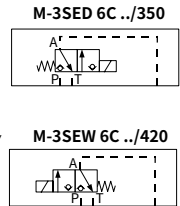

M-3SED 6C ../350

M-3SEW 6C ../420

Control cover with manual pressure adjustment, with electrical unloading function

· Types ..DBW...(Nominal sizes 16, 25 and 32)

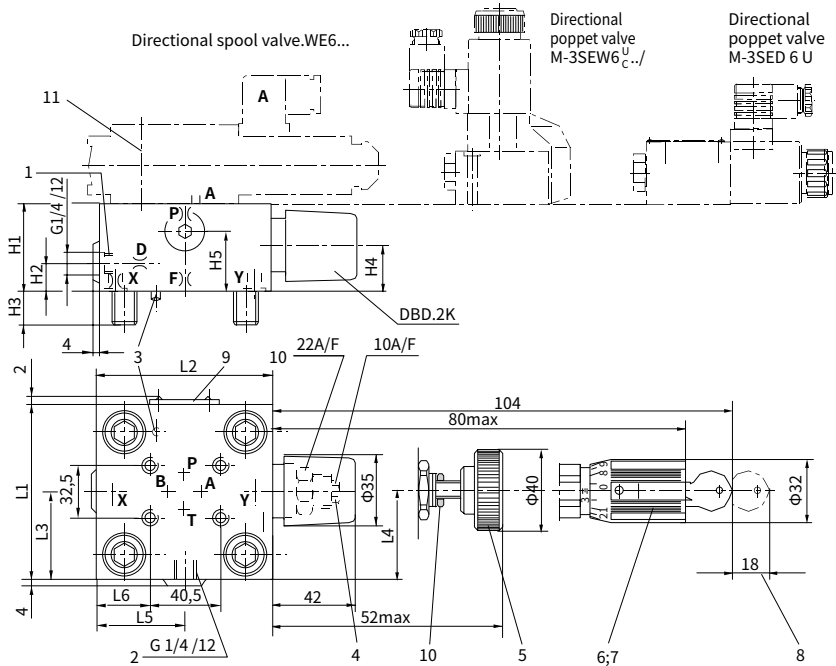

Size	H1	H2	H3	H4	H5	L1	L2	L3	L4	L5	L6	L7	Weight kg
16	40	17	15	19	28	65	80	36.5	32.5	35	7	17	1.7
25	40	19	24	19	28	85	85	49	45.5	36	8	27	2.1
32	50	26	28	26	37	100	100	56.5	53	57	31	34.5	3.8

- | | |
|---|---|
| <p>1 Optional port X used as threaded port
 2 Optional port Y used as threaded port
 3 Locating pin
 4 Version "2" adjustment
 5 Version "1" adjustment
 6 Version "3" adjustment
 7 Version "4" adjustment</p> | <p>8 Space required to remove the key
 9 Nameplate
 10 Lock nut
 11 Directional valve: ..WE6...
 Valve fixing screws: GB/T 70.1-M5×50-10.9,
 must be ordered separately</p> |
|---|---|

Control cover with manual pressure adjustment, with electrical unloading function

• Types ..DBW...; ..DBS... (Nominal sizes 40 and 50)

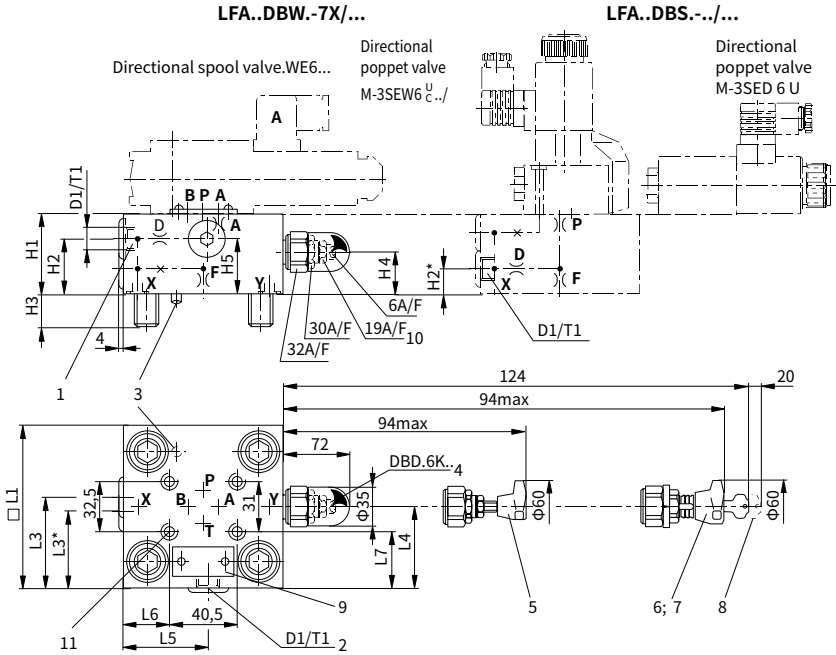

Size	D1	T1	H1	H2	H3	H4	H5	L1	L3	L4	L5	L6	L7	Weight kg
40	G1/4	12	60	46	32	27	40	125	62.5	76	68	43.5	47	6.8
50	G1/2	14	68	51	34	35	50	140	67.5	84	74.5	51	54.5	9.6

* Dimensions for control cover LFA..DBS..

- 1 Optional port X used as threaded port
- 2 Optional port Y used as threaded port
- 3 Locating pin
- 4 Version "2" adjustment
- 5 Version "1" adjustment
- 6 Version "3" adjustment

7 Version "4" adjustment

- 8 Space required to remove the key
- 9 Nameplate
- 10 Lock nut
- 11 Directional valve: WE6...

Valve fixing screws: GB/T 70.1-M5×50-10.9, must be ordered separately

Control cover with manual pressure adjustment, with electrical unloading function

• Types ..DBW...; ..DBS... (Nominal sizes 63)

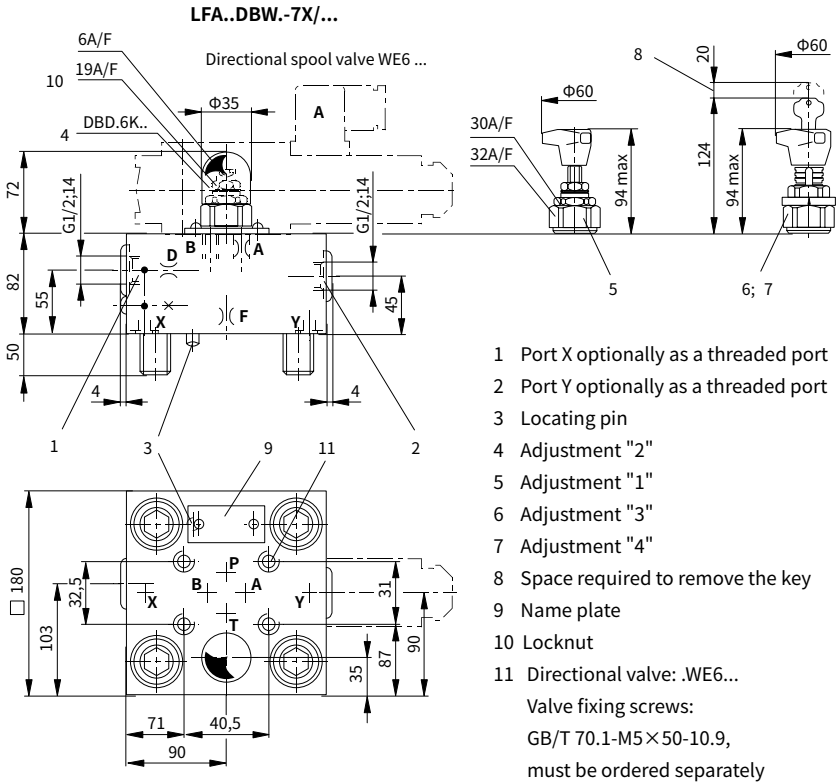

Control cover with manual pressure adjustment, with electrical unloading function

• Types ..DBW...; ..DBS... (Nominal sizes 80 and 100)

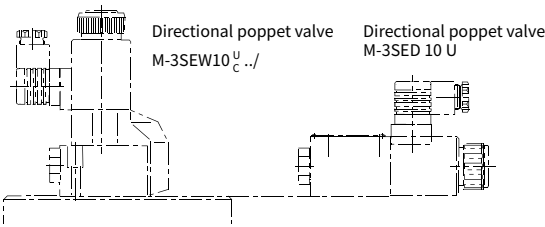
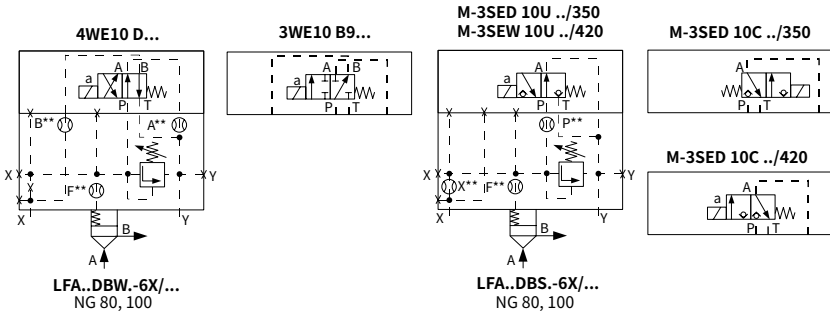

NG	80	100
D2	250	300
H1	100	100
H2	30	30
H3	45	51
H4	52	52
L8	78	85

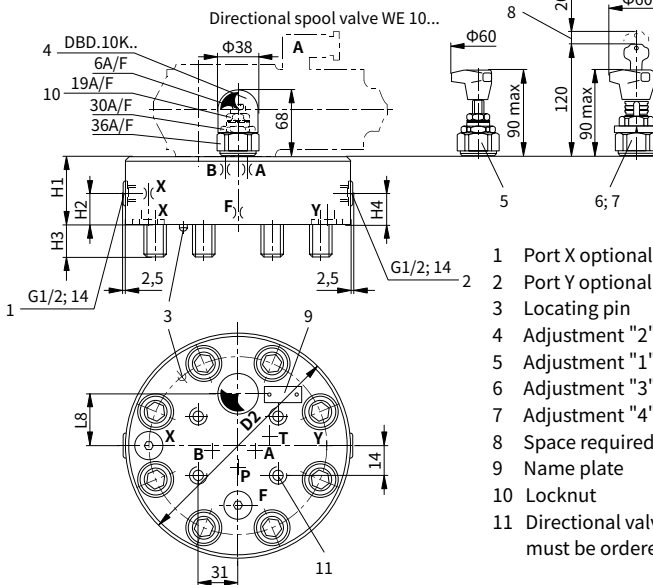

- 1 Port X optionally as a threaded port
- 2 Port Y optionally as a threaded port
- 3 Locating pin
- 4 Adjustment "2"
- 5 Adjustment "1"
- 6 Adjustment "3"
- 7 Adjustment "4"
- 8 Space required to remove the key
- 9 Name plate
- 10 Locknut
- 11 Directional valve: WE6... must be ordered separately

Control cover with manual pressure adjustment, with isolation function

· Types ..DBWD... (Nominal sizes 16 to 100)

	L-LFA		DBWD	- 7X /	
Control cover					
Nominal size 16	= 16				
Nominal size 25	= 25				
Nominal size 32	= 32				
Nominal size 40	= 40				
Nominal size 50	= 50				
Nominal size 63	= 63				
Nominal size 80	= 80				
Nominal size 100	= 100				
Control covers version					
Rotary knob	=1				
Hexagon waith protective c	=2				
Lockable rotary knob with scale (H-key to automotive industry standards)	=3				
Rotary knob with scale	=4				
Series 60 to 69 (NG80 and NG100)	=6X				
(60 to 69: unchanged installation and connection dimensions)					
Series 70 to 79 (NG16 to NG63)	=7X				
(70 to 79: unchanged installation and connection dimensions)					

No code= NBR seals
 V = FKM seals
 (Other seals, please consult us!)
Caution:
 The harmony of seals and fluid must be taken into account.

Pressure ratings
 (Max. permissible pressure of pilot valve must be taken into account)

Sizes 16, 25 and 32	Sizes 40, 50 and 63
025 = 25 bar	025 = 25 bar
050 = 50 bar	050 = 50 bar
100 = 100 bar	100 = 100 bar
200 = 200 bar	200 = 200 bar
315 = 315 bar	315 = 315 bar
420 = 420 bar	400 = 400 bar

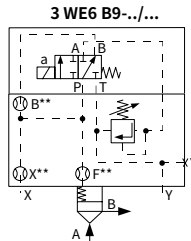
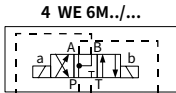
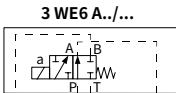

LFA..DBWD.-7X/...
NG 16

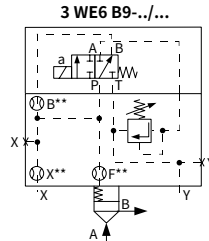

LFA..DBWD.-7X/...
NG 25, 32

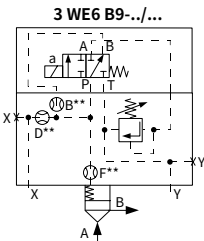

LFA..DBWD.-7X/...
NG 40, 50, 63

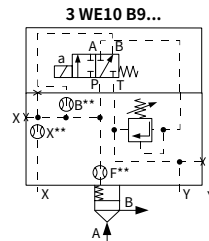
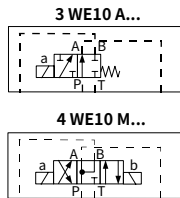

LFA..DBWD.-6X/...
NG 80, 100

Control cover with manual pressure adjustment, with isolation function

• Types ..DBWD... (Nominal sizes 16, 25, 32, 40 and 50)

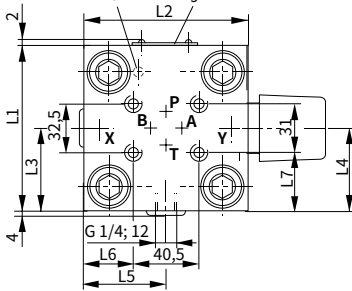
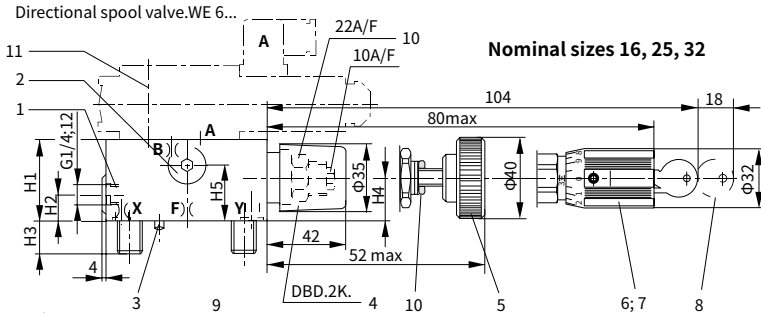

Nominal sizes 40, 50

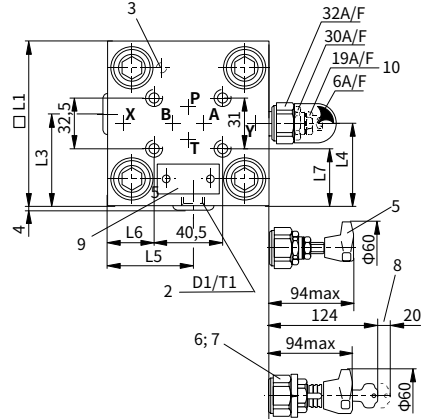
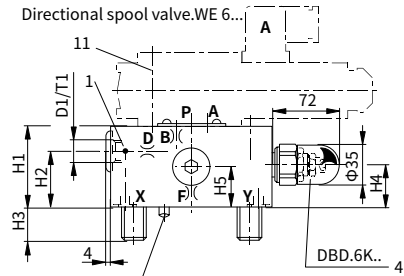

- 1 Port X optionally as a threaded port
- 2 Port Y optionally as a threaded port
- 3 Locating pin
- 4 Adjustment "2"
- 5 Adjustment "1"
- 6 Adjustment "3"
- 7 Adjustment "4"
- 8 Space required to remove the key
- 9 Name plate
- 10 Locknut
- 11 Directional valve: .WE6...
Valve fixing screws:
GB/T 70.1-M5×50-10.9,
must be ordered separately

05

Control cover with manual pressure adjustment, with isolation function

· Types ..DBWD... (Nominal sizes 63, 80 and 100)

Nominal size 63

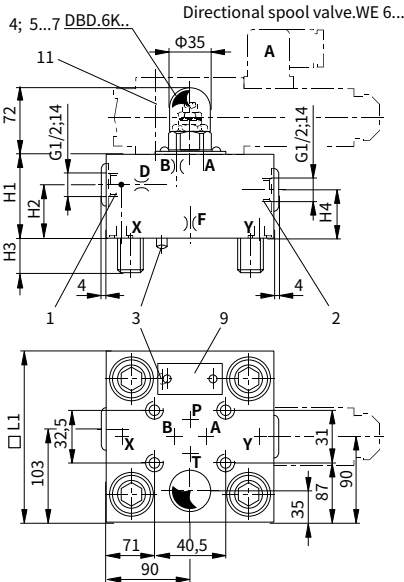

NG	16	25	32	40	50	63	80	100
D1				G1/4	G1/2			
H1	40	40	50	60	68	82	100	100
H2		19	26	46	50	55	67	67
H3	15	24	28	32	34	50	45	51
H4	19	19	26	27	35	45	58	58
H5	28	28	37	16	20			
L1	65	85	100					
□ L1				125	140	180		
L2	80	85	100					
L3		49	56.5	62.5	70			
L4	32.5	45.5	53	76	84			
L5	35	36	57	68	75			
L6	7	8	31	43.5	51			
L7	17	27	34.5	47	54.5			
T1				12	14			
L8							75	85

Nominal sizes 80 and 100

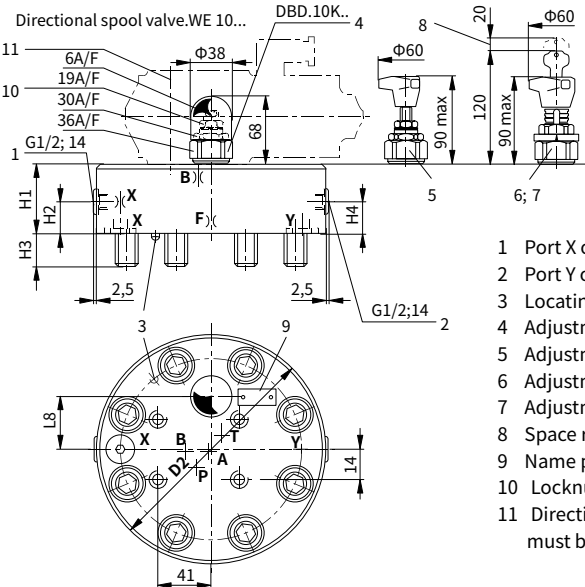

- 1 Port X optionally as a threaded port
- 2 Port Y optionally as a threaded port
- 3 Locating pin
- 4 Adjustment "2"
- 5 Adjustment "1"
- 6 Adjustment "3"
- 7 Adjustment "4"
- 8 Space required to remove the key
- 9 Name plate
- 10 Locknut
- 11 Directional valve: WE6... must be ordered separately

Control cover with 2 manual pressure adjustments, selected electrically

· Types ..DBU2A...; ..DBU2B... (Nominal sizes 16, 25 and 32)

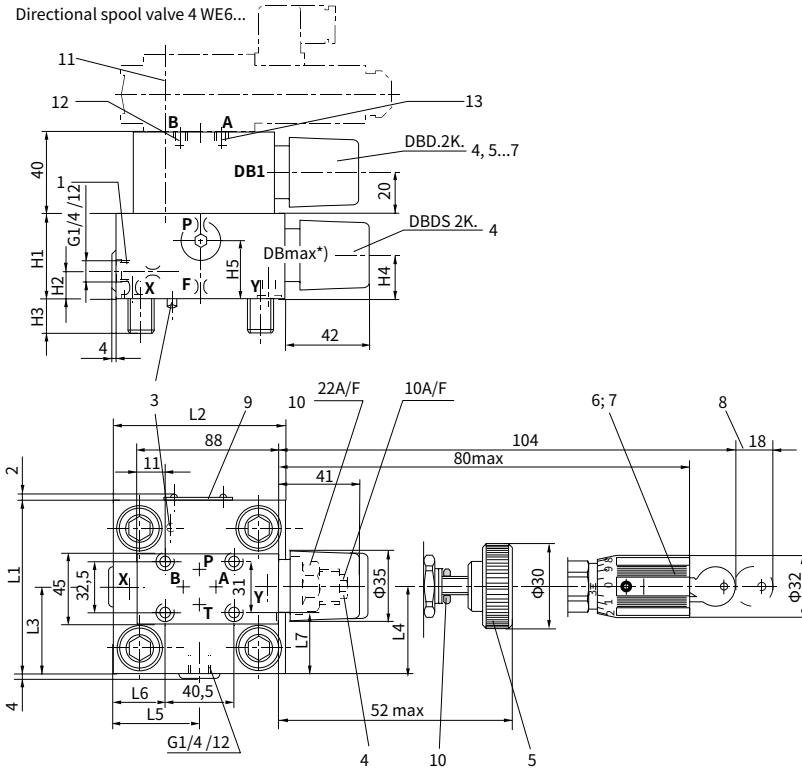

- | | |
|--|--|
| 1 Port X optionally as a threaded port | 9 Name plate |
| 2 Port Y optionally as a threaded port | 10 Locknut |
| 3 Locating pin | 11 Directional valve: WE6... |
| 4 Adjustment "2" | Valve fixing screws: GB/T 70.1-M5×90-10.9,
must be ordered separately |
| 5 Adjustment "1" | 12 Lopped M6 used for ...DBU 2A... |
| 6 Adjustment "3" | 13 Lopped M6 used for ...DBU 2B... |
| 7 Adjustment "4" | *) For DB max. only adjustment type "2" is possible |
| 8 Space required to remove the key | |

Size	H1	H2	H3	H4	H5	L1	L2	L3	L4	L5	L6	L7	Weight kg
16	40	17	15	19	28	65	80	36.5	32.5	35	7	17	2.8
25	40	19	24	19	28	85	85	49	45.5	36	8	27	3.4
32	50	26	28	26	37	100	100	56.5	53	57	31	34.5	4.8

Control cover with manual pressure adjustment, selected electrically

• Types ..DBU2A...; ..DBU2B... (Nominal sizes 40, 50 and 63)

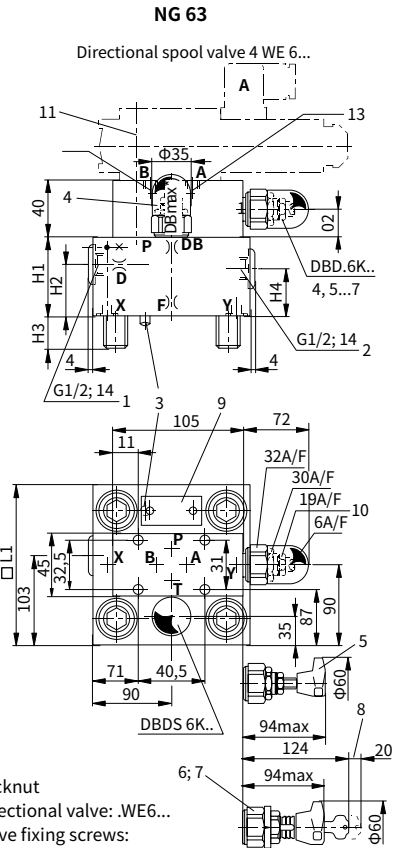
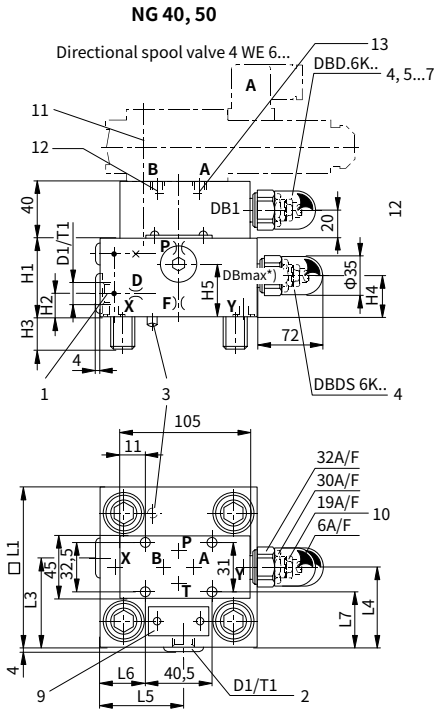

- 1 Port X optionally as a threaded port
- 2 Port Y optionally as a threaded port
- 3 Locating pin
- 4 Adjustment "2"
- 5 Adjustment "1"
- 6 Adjustment "3"
- 7 Adjustment "4"
- 8 Space required to remove the key
- 9 Name plate

- 10 Locknut
 - 11 Directional valve: .WE6...
Valve fixing screws:
GB/T 70.1-M5×90-10.9,
must be ordered separately
 - 12 Lopped M6 used for ...DBU 2A...
 - 13 Lopped M6 used for ...DBU 2B...
- *) For DB max. only adjustment type "2" is possible

Size	D1	T1	H1	H2	H3	H4	H5	L1	L3	L4	L5	L6	L7	Weight kg
40	G1/4	12	60	17	32	27	40	125	69	76	68	43.5	47	8.2
50	G1/2	14	68	19.5	34	35	50	140	80	84	74.5	51	54.5	11.1
63			82	55	50	45		180						20.4

Control cover with manual pressure adjustment, selected electrically

• Types ..DBU2A...; ..DBU2B... (Nominal sizes 80 and 100)

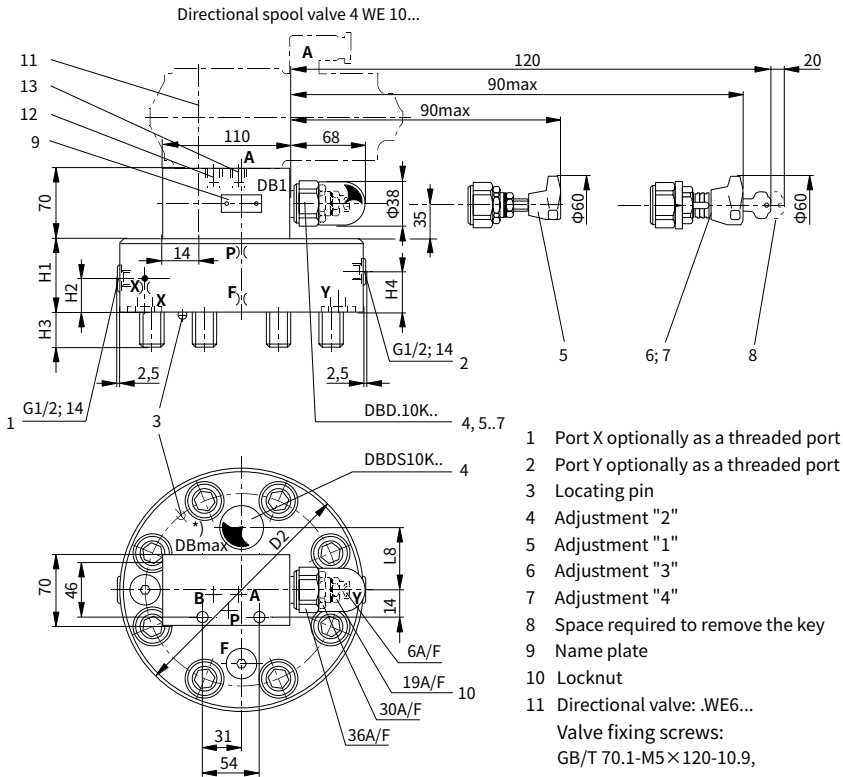

- 1 Port X optionally as a threaded port
- 2 Port Y optionally as a threaded port
- 3 Locating pin
- 4 Adjustment "2"
- 5 Adjustment "1"
- 6 Adjustment "3"
- 7 Adjustment "4"
- 8 Space required to remove the key
- 9 Name plate
- 10 Locknut
- 11 Directional valve: WE6...
Valve fixing screws:
GB/T 70.1-M5×120-10.9,
must be ordered separately
- 12 Lopped M8 used for ...DBU 2A...
- 13 Lopped M8 used for ...DBU 2B...

NG	D2	H1	H2	H3	H4	L8
80	250	100	30	45	52	75
100	300	100	30	51	52	85

*) For DB max. only adjustment type "2" is possible "2" is possible

05

Control cover with 3 manual pressure adjustments, selected electrically

• Types ..DBU3D... (Nominal sizes 16 to 100)

L-LFA		DBU3D	- 7X /	A...	B...	
-------	--	-------	--------	------	------	--

Control cover

Nominal size 16	=16
Nominal size 25	=25
Nominal size 32	=32
Nominal size 40	=40
Nominal size 50	=50
Nominal size 63	=63
Nominal size 80	=80
Nominal size 100	=100

Control covers version
(Only for ..DB1..or ..Db2..) *)

Rotary knob	=1
Hexagon with protective cap	=2
Lockable rotary knob with scale (H-key to automotive industry standards)	=3
Rotary knob with scale	=4
Series 60 to 69 (NG80 and NG100)	=6X
(60 to 69: unchanged installation and connection dimensions)	
Series 70 to 79 (NG16 to NG63)	=7X
(70 to 79: unchanged installation and connection dimensions)	

*) For DB1 or DB2, choose the same adjustment type

No code = NBR seals
V = FKM seals
(Other seals, please consult us!)

Caution:
The harmony of seals and fluid must be taken into account.

Pressure ratings
(Max. permissible pressure of pilot valve must be taken into account)

Sizes 16, 25 and 32	Sizes 40, 50, 63
025 = 25bar	025 = 25bar
050 = 50bar	050 = 50bar
100 = 100bar	100 = 100bar
200 = 200bar	200 = 200bar
315 = 315bar	315 = 315bar
420 = 420bar	400 = 400bar

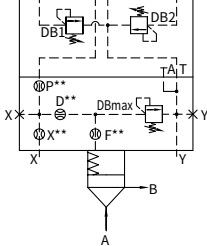
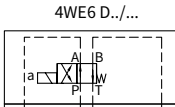
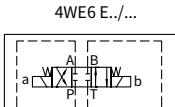
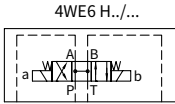

L-LFA...DBU3D.-7X/...
Nominal sizes 16, 25 and 32

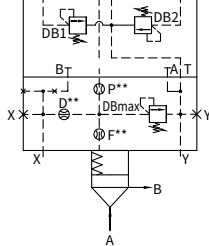
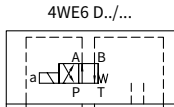
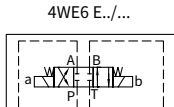
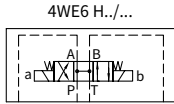

L-LFA...DBU3D.-7X/...
Nominal sizes 40, 50 and 63

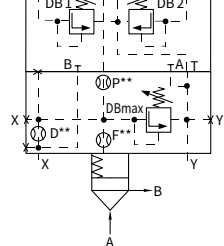
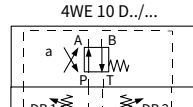
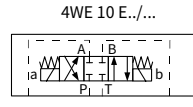
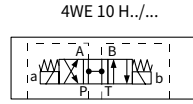

L-LFA...DBU3D.-7X/...
Nominal sizes 80 and 100

Control cover with 3 manual pressure adjustments, selected electrically

· Types ..DBU3D... (Nominal sizes 16, 25 and 32)

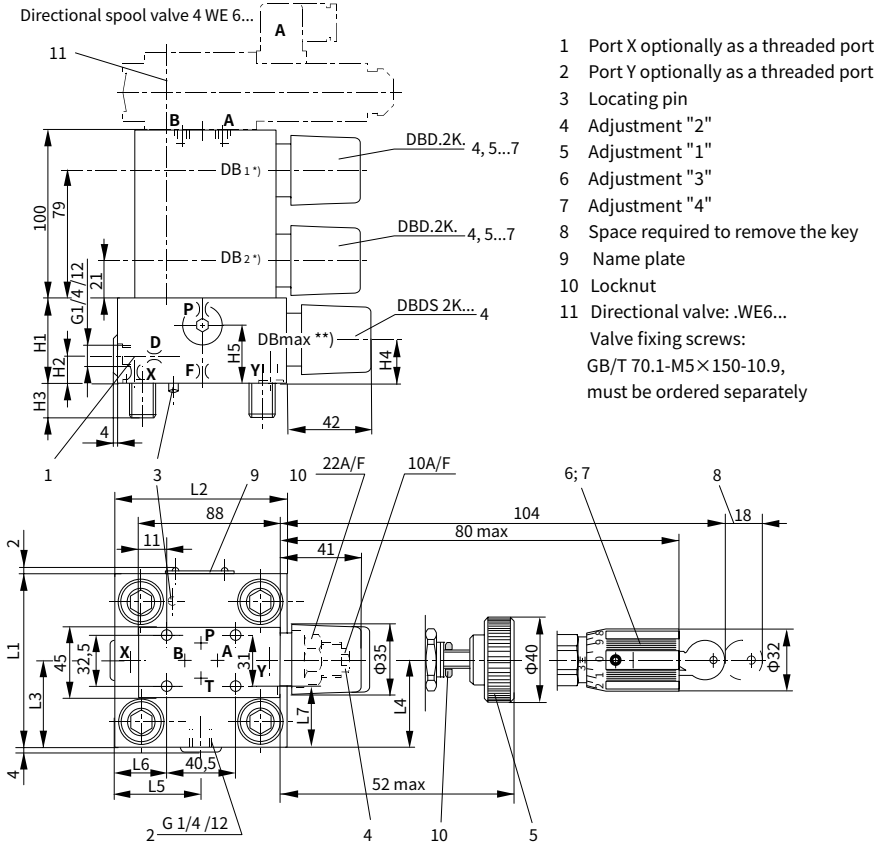

- 1 Port X optionally as a threaded port
- 2 Port Y optionally as a threaded port
- 3 Locating pin
- 4 Adjustment "2"
- 5 Adjustment "1"
- 6 Adjustment "3"
- 7 Adjustment "4"
- 8 Space required to remove the key
- 9 Name plate
- 10 Locknut
- 11 Directional valve: WE6...
Valve fixing screws:
GB/T 70.1-M5×150-10.9,
must be ordered separately

Size	H1	H2	H3	H4	H5	L1	L2	L3	L4	L5	L6	L7	Weight kg
16	40	17	15	19	28	65	80	36.5	32.5	35	7	17	4.7
25	40	19	24	19	28	85	85	49	45.5	36	8	27	5.1
32	50	26	28	26	37	100	100	56.5	53	57	31	34.5	6.8

*) Same adjustment for ..DB1..and ..DB2..

***) For DBmax. only adjustment "2" is possible

Control cover with 3 manual pressure adjustments, selected electrically

• Types ..DBU3D... (Nominal sizes 40 and 50)

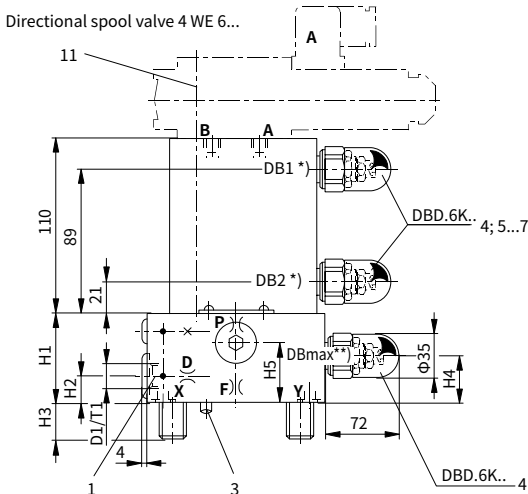

- 1 Port X optionally as a threaded port
- 2 Port Y optionally as a threaded port
- 3 Locating pin
- 4 Adjustment "2"
- 5 Adjustment "1"
- 6 Adjustment "3"
- 7 Adjustment "4"
- 8 Space required to remove the key
- 9 Name plate
- 10 Locknut
- 11 Directional valve: .WE6...
Valve fixing screws: GB/T 70.1-M5×160-10.9, must be ordered separately

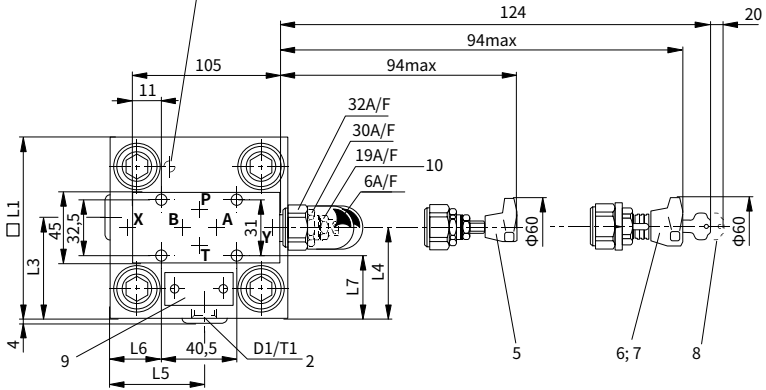

Size	D1	T1	H1	H2	H3	H4	H5	L1	L3	L4	L5	L6	L7	Weight kg
40	G1/4	12	60	17	32	27	40	125	69	76	68	43.5	47	10.7
50	G1/2	14	68	19.5	34	35	50	140	80	84	74.5	51	54.5	13.4

*) Same adjustment for ..DB1..and ..DB2..

***) For DBmax. only adjustment version "2" is possible

Control cover with 3 manual pressure adjustments, selected electrically

• Types ..DBU3D... (Nominal size 63)

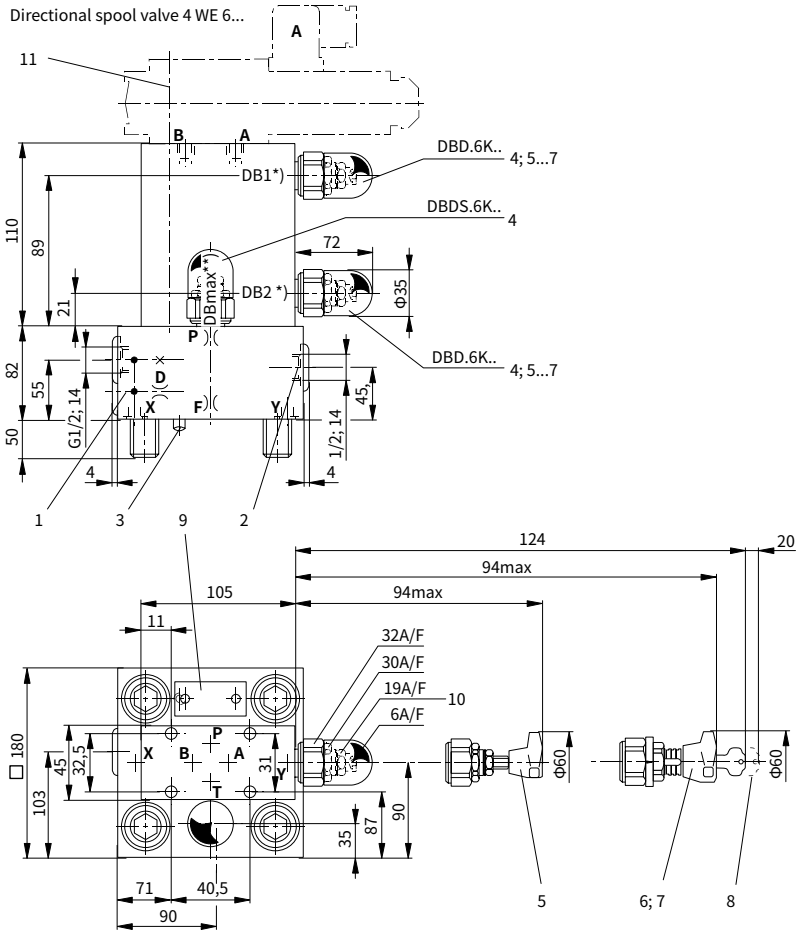

- 1 Port X optionally as a threaded port
- 2 Port Y optionally as a threaded port
- 3 Locating pin
- 4 Adjustment "2"
- 5 Adjustment "1"
- 6 Adjustment "3"
- 7 Adjustment "4"
- 8 Space required to remove the key

- 9 Name plate
- 10 Locknut
- 11 Directional valve: ..WE6...
Valve fixing screws:
GB/T 70.1-M5×160-10.9, must be ordered separately

*) Same adjustment for ..DB1.. and ..DB2..

**) For DBmax. only adjustment version "2" is possible

Control cover for electrical-proportional pressure adjustment, without maximum pressure limitation

(Dimensions in mm)

· Types ..DBE... (Nominal sizes 16 to 63)

Control cover		L-LFA		DBE	-	7X	/
Nominal size 16=16	Nominal size 40= 40						
Nominal size 25=25	Nominal size 50= 50						
Nominal size 32=32	Nominal size 63= 63						
For mounting a proportional pressure relief valve without electrical feedback		= DBE					

No code =	NBR seals
V =	FKM seals
(Other seals, please consult us!)	
Caution: The harmony of seals and fluid must be taken into account.	
7X=	Series 70 to 79
(70 to 79: unchanged installation and connection dimensions)	

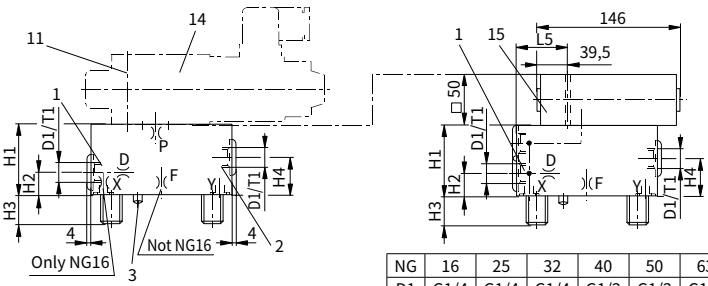
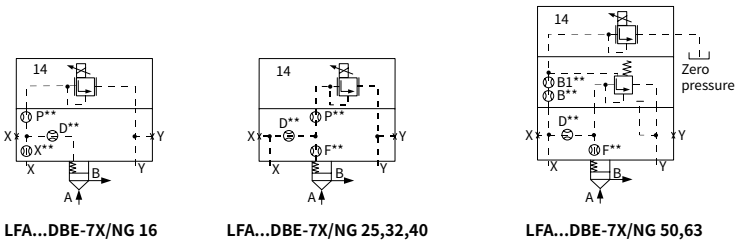

NG	16	25	32	40	50	63
D1	G1/4	G1/4	G1/4	G1/2	G1/2	G1/2
H1	40	40	50	60	68	82
H2	17	19	26	30	32	30
H3	15	24	28	32	34	50
H4	20	19	26	30	32	40
L1	65	85	100	125	140	180
L2	80	85	100	125	140	180
L3	36.5	49	56.5	72	80	100
L4	23.5	36	43.5	53	50	80
L5	7	23.5	31	43.5	51	71
L6	17	27	34.5	47	54.5	74.5
T1	12	12	12	14	14	14

- 1 Port X optionally as a threaded port
- 2 Port Y optionally as a threaded port
- 3 Locating pin
- 9 Name plate
- 11 Valve fixing screws are included within the control cover scope of supply
- 14 Prop. pressure relief valve type DBET-L5X/...
- 15 Pressure relief valve NG 6 (included within the scope of supply)

Control cover for electrical-proportional pressure adjustment, with maximum pressure limitation

(Dimensions in mm)

• Types ..DBEM... (Nominal sizes 16 to 100)

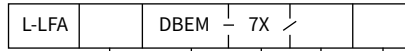

Nominal size 16	= 16
Nominal size 25	= 25
Nominal size 32	= 32
Nominal size 40	= 40
Nominal size 50	= 50
Nominal size 63	= 63
Nominal size 80	= 80
Nominal size 100	= 100

For mounting a proportional pressure relief valve
Without electrical feedback and
with maximum pressure safety = DBEM

Series 60 to 69 (NG80 and NG100) = 6X
(60 to 69: unchanged installation and connection dimensions)
Series 70 to 79 (NG16 to NG63) = 7X
(70 to 79: unchanged installation and connection dimensions)

No code = NBR seals
V = FKM seals
(Other seals, please consult us!)
Caution:
The harmony of seals and fluid
must be taken into account.

Pressure ratings
(Max. permissible pressure of pilot valve
must be taken into account)

NG 16, 25 and 32	NG 40, 50, 63, 80, 100
025 = 25bar	025 = 25bar
050 = 50bar	050 = 50bar
100 = 100bar	100 = 100bar
200 = 200bar	200 = 200bar
315 = 315bar	315 = 315bar
420 = 420bar	400 = 400bar

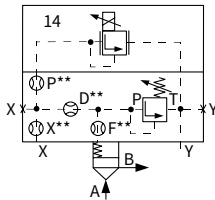

LFA..DBEM-7X/...
NG16, 25, 32

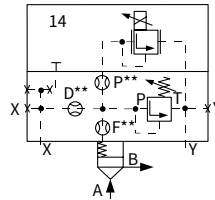

LFA..DBEM-7X/...
NG40

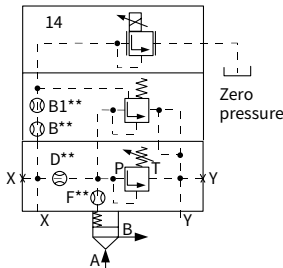

LFA..DBEM-7X/...
NG 50, 63

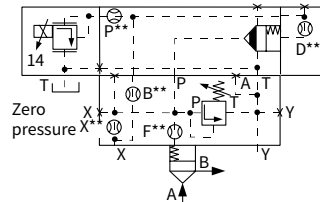

LFA..DBEM-6X/...
NG 80, 100

05

Control cover for electrical-proportional pressure adjustment, with maximum pressure limitation

(Dimensions in mm)

· Types ..DBEM... (Nominal sizes 63, 80 and 100)

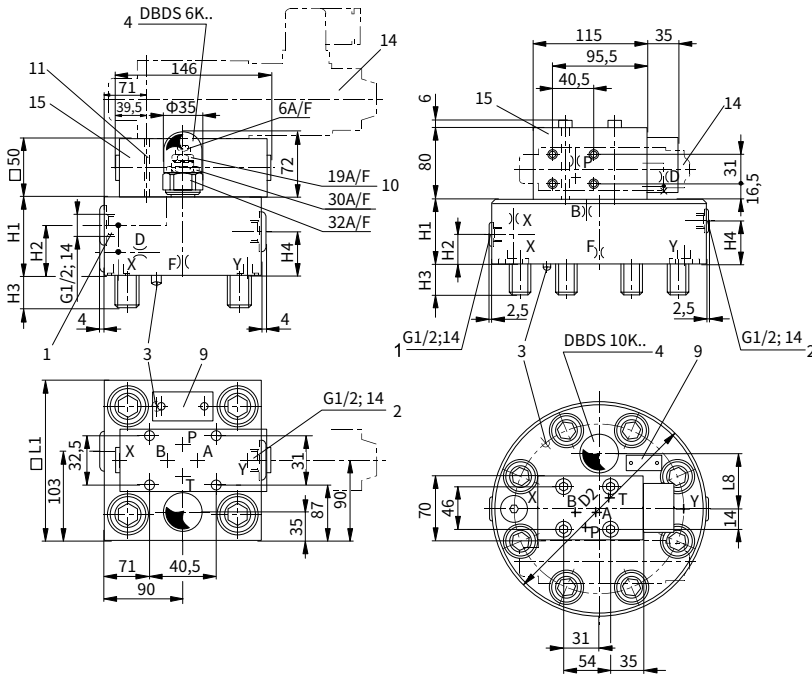

Ports T and Y - zero pressure

- 1 Port X optionally as a threaded port
- 2 Port Y optionally as a threaded port
- 3 Locating pin
- 4 Adjustment "2"
- 9 Name plate
- 10 Locknut

- 11 Valve fixing screws are included within the control cover scope of supply
 - 14 Proportional pressure relief valve type DBET-5X/...Y G24-1
 - 15 Pressure relief valve NS 6 (is included within the scope of supply)
- ³⁾ 1 = G 1/4 threaded port T, special poppet

NG	H1	H2	H3	H4	D2	□ L1	L8
63	82	55	50	45		180	
80	100	30	45	52	250		75
100	100	30	51	52	600		85

2-way cartridge valves -pressure control function

5.2-2(1)

Pressure reducing valve function

Cartridge valve Type L-LC.DR...

Ordering code

- Pressure reducing cartridge valve (without control cover type L-LFA..DB..)

L-LC			DR		E	7X	∕
Control cover							
Nominal size 16	= 16						
Nominal size 25	= 25						
Nominal size 32	= 32						
Nominal size 40	= 40						
Nominal size 50	= 50						
Nominal size 63	= 63						
Pressure reducing valve function							
Shutoff pressure approx. 0 bar (without spring)	= 00						
Shutoff pressure approx. 2 bar	= 20						
Shutoff pressure approx. 3 bar	= 30 ¹⁾						
Shutoff pressure approx. 4 bar	= 40						
Shutoff pressure approx. 5 bar	= 50 ²⁾						
Shutoff pressure approx. 8 bar	= 80 ³⁾						

No code = NBR seals
 V = FKM seals
 (Other seals, please consult us!)

Caution:
 The harmony of seals and fluid must be taken into account.

7X = Series 70 to 79
 (70 to 79: unchanged installation and connection dimensions)

Spool valve without accurate control groove

¹⁾ Closing pressure 3.0 bar only for NG 16 for mounting a pilot operated pressure relief valve type DBC . -LSX/...

²⁾ Only for NS 16, 25 and 32

³⁾ Special installation space is required

Symbol: Cartridge valve

Type L-LC..DR..

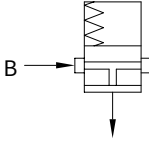

Technical data

Max. working pressure	Port A and B bar	315					
Max. flow-rate (reference)	Size	16	25	32	40	50	63
	L-LC..DR20.../.. L/min	100	200	300	750	1000	1600
	L-LC..DR40.../..	150	300	450	1000	1300	2000
Weight	kg	0.25	0.5	1.1	1.9	3.9	7.2
Fluid		Mineral oil suitable for NBR and FKM seal Phosphate ester for FKM seal					
Fluid temperature range	°C	-30 to +80 (NBR seal)					
		-20 to +80 (FKM seal)					
Viscosity range	mm ² /s	2.8 to 380					
Degree of contamination		Maximum permissible degree of fluid contamination: Class 9. NAS 1638 or 20/18/15, ISO4406 ¹⁾					

For applications outside these parameters, please consult us.

¹⁾ To prevent the problem caused by fluid contamination, fluid cleanliness mentioned above must be met.

Caution!

It is composed with cartridge valve type L-LC..DR...and control cover type L-LFA..DB..

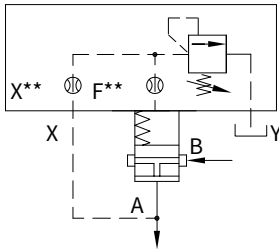

Pressure reducing function Normally open.

Example: $\frac{\text{Type L-LFA..DB...}}{\text{Type L-LC..DR40...}}$

Characteristic curves (Measured at $\vartheta_{oil}=40^{\circ}\text{C} \pm 5^{\circ}\text{C}$, using HLP46)

L-LC16DR...

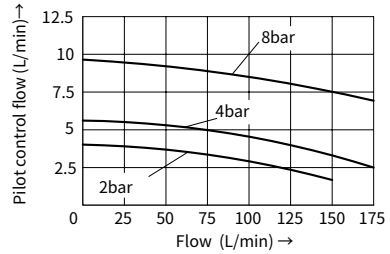
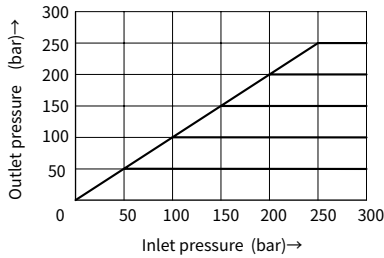
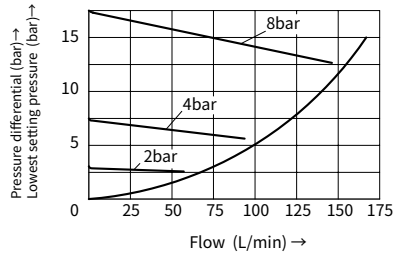
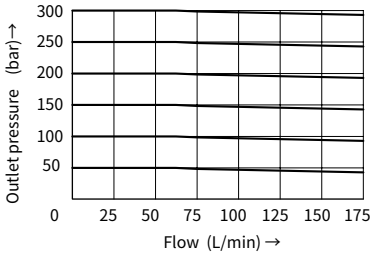

Measured when $p_a=50\text{bar}$

L-LC 25 DR...

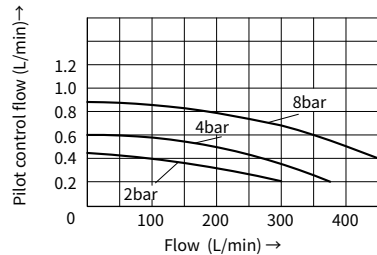
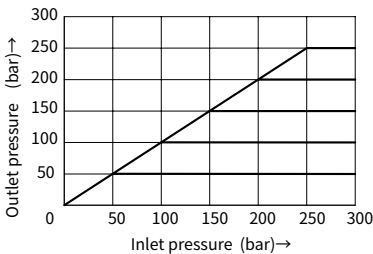
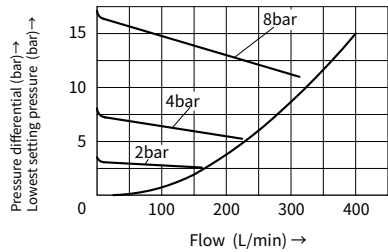
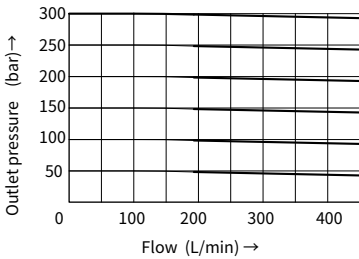

Measured when $p_a=50\text{bar}$

Characteristic curves (Measured at $\vartheta_{oil} = 40^{\circ}C \pm 5^{\circ}C$, using HLP46)

L-LC 32 DR...

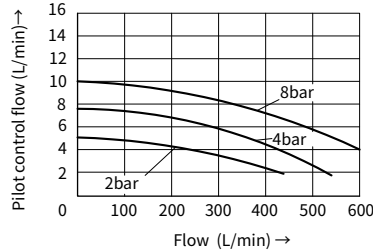
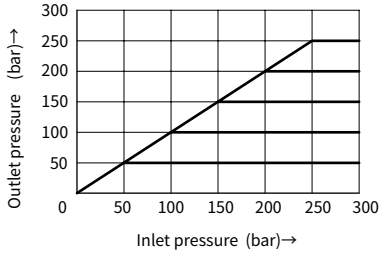
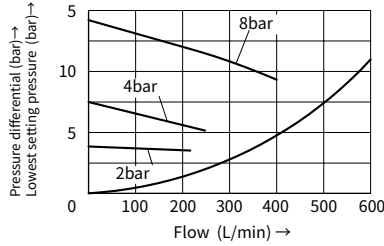
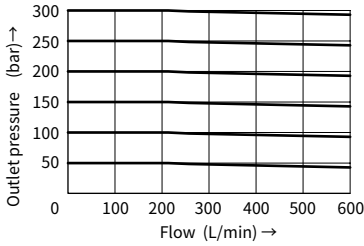

Measured when $p_a = 50\text{bar}$

L-LC 40 DR...

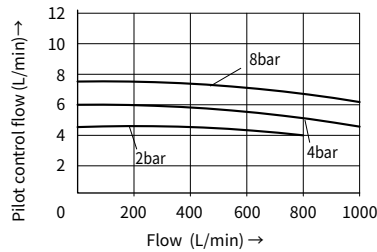
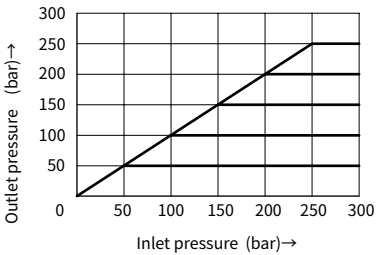
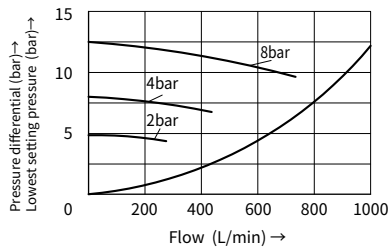
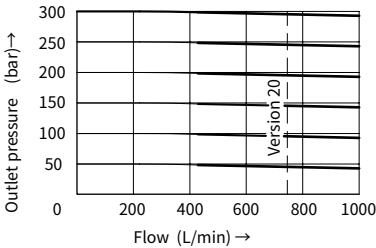

Measured when $p_a = 50\text{bar}$

Characteristic curves (Measured at $\theta_{oil}=40^{\circ}\text{C} \pm 5^{\circ}\text{C}$, using HLP46)

L-LC 50 DR...

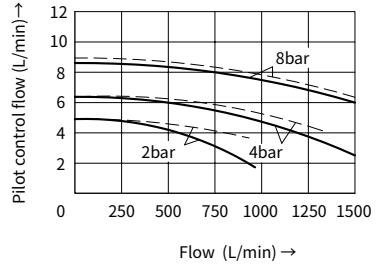
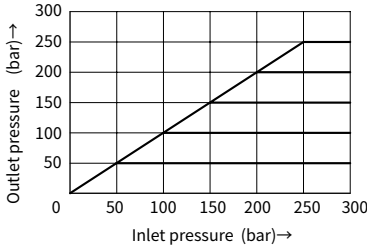
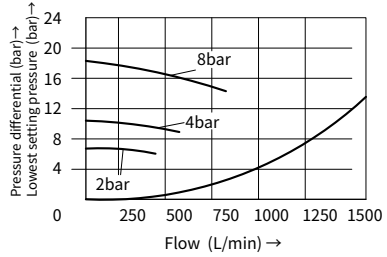
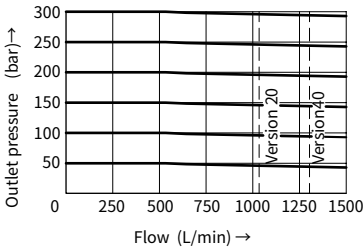

L-LC 63 DR...

Measured when $p_a=50\text{bar}$
 — $p_e=100\text{bar}$
 - - - $p_e=350\text{bar}$

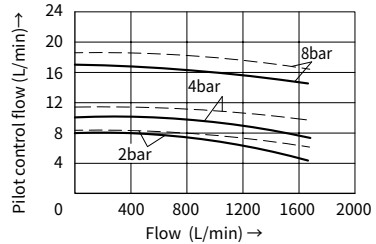
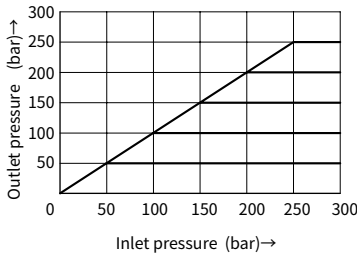
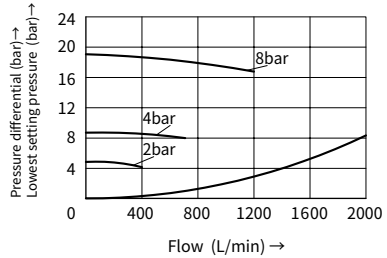
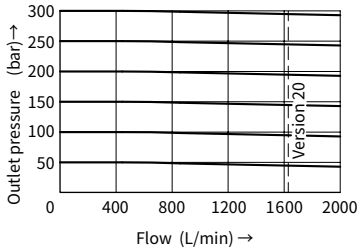

Measured when $p_a=50\text{bar}$

05

O-rings for cartridge valve type L-LC

Nominal sizes 16, 25 and 32

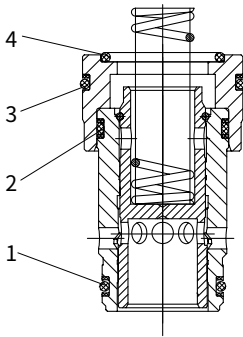

Type L-LC..DR...

Nominal sizes 40, 50 and 63

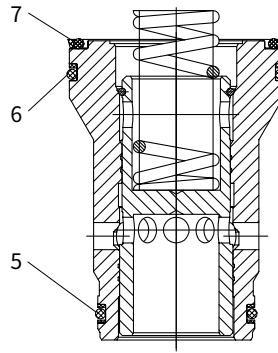

Type L-LC..DR...

O-rings

05

No.	Nominal size		
	16	25	32
1	21.2×1.8	28×2.65	40×2.65
2	22.4×2.65	32.5×2.65	43.7×3.55
3	26.5×2.65	38.7×3.55	54.5×3.55
4	20×2.65	30×2.65	37.5×3.55

No.	Nominal size		
	40	50	63
5	48.7×3.55	61.5×3.55	80×5.3
6	69×3.55	80×5.3	109×5.3
7	67×3.55	77.5×5.3	106×5.3

2-way cartridge valves -pressure control function

5.2-2(2)

Pressure reducing valve function

Control cover Type L-LFA.DR...

Technical data

Fluid	Mineral oil suitable for NBR and FKM seal						
	Phosphate ester for FKM seal						
Fluid temperature range	°C	-30 to +80 (NBR seal)					
		-20 to +80 (FKM seal)					
Viscosity range	mm ² /s	2.8 to 380					
Degree of contamination	Maximum permissible degree of fluid contamination: Class 9. NAS 1638 or 20/18/15, ISO4406 ¹⁾						
Nominal size		16	25	32	40	50	63
Weight	kg	3.1	3.6	5.2	8	11.4	20.8

(L-LFA.DR (DRW) ...for applications outside these parameters, please consult us)

¹⁾ To prevent the problem caused by fluid contamination, fluid cleanliness mentioned above must be met.

Control cover with pressure reducing function

Control cover		Control cover type
Max. working pressure at the port...		L-LFA..DR.-../... L-LFA..DRW.-../...
...X (Basic pressure)		315bar
...Y (Secondary pressure=max. remove period setting pressure)		315bar
...Z2	As control pressure	0 pressure (up to 2bar)
	Static	60bar

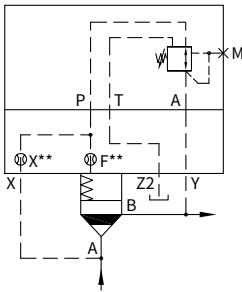

Caution:
Composed with control cover type L-LFA..DR...and cartridge type L-LC..DB... .

Pressure reducing function
Normally closed

Example: $\frac{\text{Type L-LFA..DR...}}{\text{Type L-LC..DB 40 D...}}$

05

O-rings dimensions for ports X, Y, Z1, Z2 (included within the scope of supply)

Size	Dimension mm
16	8×1.8
25	9.25×1.78
32	10.82×1.78

Size	Dimension mm
40	12×2.5
50	
63	18.72×2.62

Fixing screw (included within the scope of supply)

In accordance with GB/T70.1 10.9			
Nominal size	Quantity	Dimension	Tightening torque (Nm)
16	4	M8×45	32
25		M12×50	110
32		M16×60	270

In accordance with GB/T70.1 10.9			
Nominal size	Quantity	Dimension	Tightening torque (Nm)
40	4	M20×70	520
50		M20×80	520
63		M30×100	1800

Control cover with pressure reducing function

(Dimensions in mm)

Control cover for type DR. DRW

Nominal sizes 16, 25 and 32

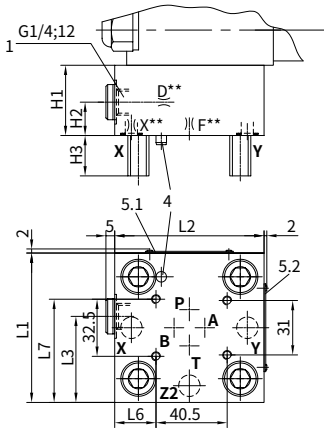

Nominal sizes 40 and 50

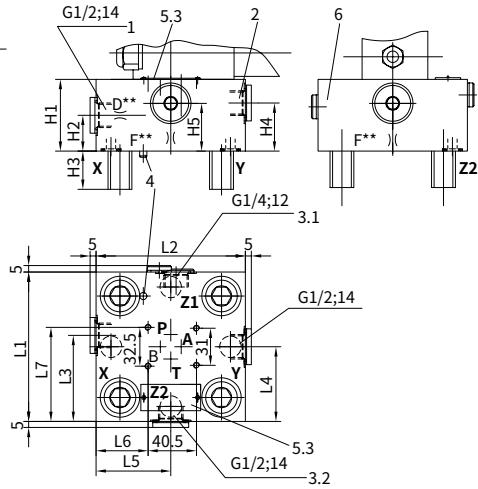

Nominal size 63

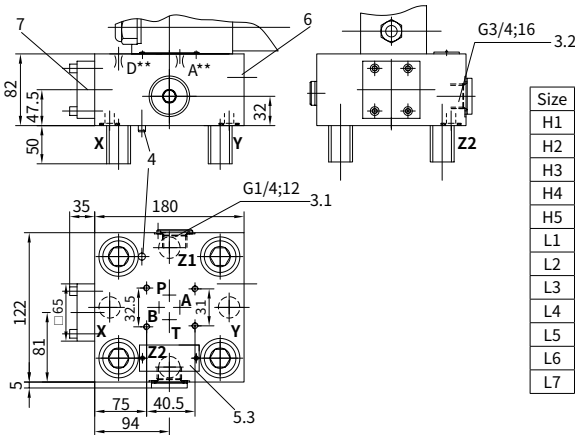

Size	16	25	32	40	50
H1	40	40	50	60	68
H2	17	19	26	30	32
H3	15	24	28	32	34
H4				40	32
H5				40	32
L1	65	85	100	125	140
L2	80	85	100	125	140
L3	36.5	49	56.5	72	80
L4				62.5	68
L5				62.5	70
L6	7	23.5	31	43.5	51
L7	49	59	66.5	79	86.5

- 1 Optional port X used as threaded port (For nominal sizes 16 to 50)
- 2 Optional port Y used as threaded port (For nominal sizes 40 and 50)
- 3.1 Optional port Z1 used as threaded port (For nominal sizes 25 to 63)
- 3.2 Optional port Z2 used as threaded port (For nominal sizes 40, 50 and 63)

- 4 Locating pin
- 5.1 Nameplate (Size 16)
- 5.2 Nameplate (Sizes 25 and 32)
- 5.3 Nameplate (Sizes 40, 50 and 63)
- 6 Check valve (For sizes 40, 50 and 63)
- 7 For control cover size 63 Cartridge size 16

Control cover with pressure reducing function

· Types ..DR... (Nominal sizes 16 to 63)

L-LFA		DR	-	7X	/		
Control cover							
Nominal size 16	= 16						
Nominal size 25	= 25						
Nominal size 32	= 32						
Nominal size 40	= 40						
Nominal size 50	= 50						
Nominal size 63	= 63						
Control covers version							
Regulation form:							
Rotary knob	= 1						
Hexagon with protective cap	= 2						
Lockable rotary knob with scale	= 3						
Rotary knob with scale	= 4						
						No code =	NBR seals
						V =	FKM seals
							(Other seals, please consult us!)
							Caution:
							The harmony of seals and fluid must be taken into account.
						025 =	Max. secondary pressure 25 bar
						075 =	Max. secondary pressure 75 bar
						150 =	Max. secondary pressure 150 bar
						210 =	Max. secondary pressure 210 bar
						315 =	Max. secondary pressure 315 bar
						7X =	Series 70 to 79 (70 to 79: unchanged installation and connection dimensions)

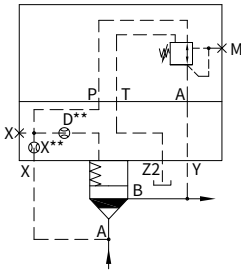

L-LFA...DR.7X/...
Nominal size 16

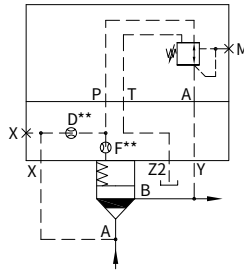

L-LFA...DR.7X/...
Nominal sizes 25 and 32

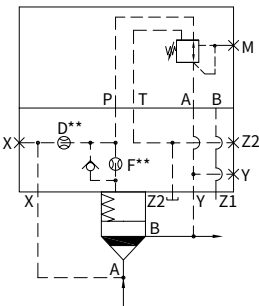

L-LFA...DR.7X/...
Nominal sizes 40 and 50

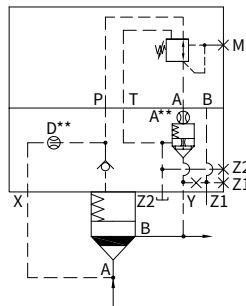

L-LFA...DR.7X/...
Nominal size 63

Control cover with pressure reducing function

(Dimensions in mm)

• Types ..DR... (Nominal sizes 16 to 63)

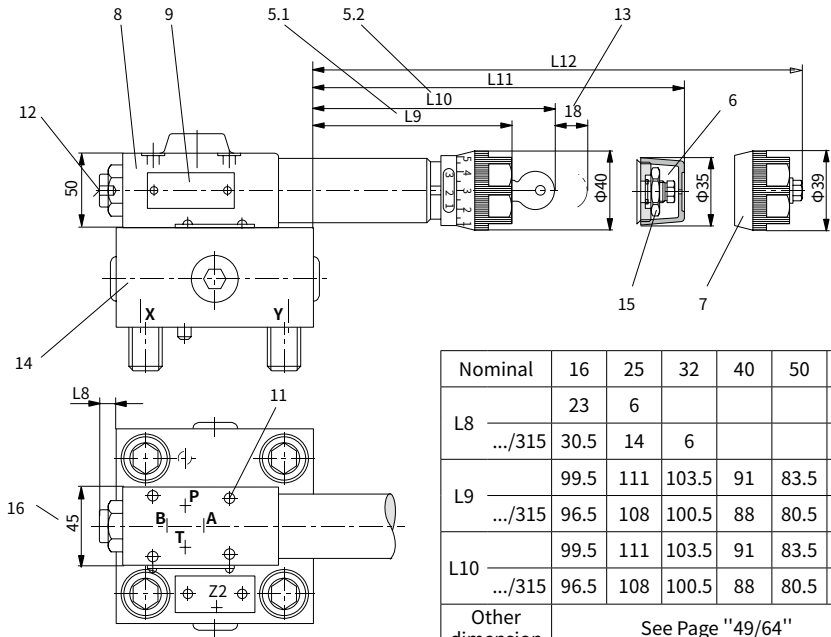

- 5.1 Adjustment element "4"
- 5.2 Adjustment element "3"
- 6 Adjustment element "2"
- 7 Adjustment element "1"
- 8 Direct operated pressure reducing valve
(is included within the scope of supply)
- 9 Name plate for pressure reducing valves
- 11 Valve fixing screws
M5×50 GB/T 70.1-10.9 M_A = 8.9 Nm
are included within the control cover
scope of supply

- 12 Pressure gauge port G1/4, 12 deep;
Socket screw A/F6
- 13 Space required to remove the key
- 14 Control cover
- 15 Locknut A/F24
- 16 For type .../315 → 50 mm

Control cover with pressure reducing function

· Types ..DRW... (Nominal sizes 16 to 63)

L-LFA		DRW	- 7X	/	
Control cover					
Nominal size 16	= 16				No code = NBR seals V = FKM seals (Other seals, please consult us!) Caution: The harmony of seals and fluid must be taken into account.
Nominal size 25	= 25				
Nominal size 32	= 32				
Nominal size 40	= 40				
Nominal size 50	= 50				
Nominal size 63	= 63				
Control covers version					025 = Max. secondary pressure 25 bar 075 = Max. secondary pressure 75 bar 150 = Max. secondary pressure 150 bar 210 = Max. secondary pressure 210 bar 315 = Max. secondary pressure 315 bar
Regulation form:					7X = Series 70 to 79 (70 to 79: unchanged installation and connection dimensions)
Rotary knob		= 1			
Hexagon with protective cap		= 2			
Lockable rotary knob with scale		= 3			
Rotary knob with scale		= 4			

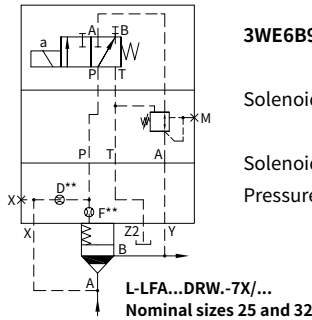
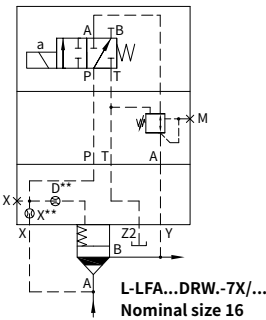

3WE6B9...

Solenoid breakaway → Closed

Solenoid electrified →

Pressure reducing function

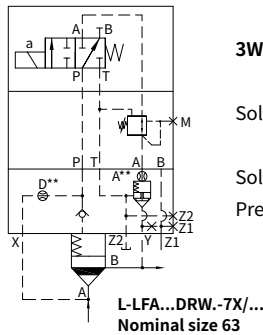
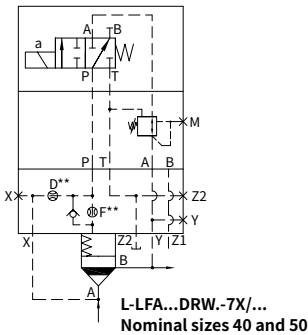

3WE6B9...

Solenoid breakaway → Closed

Solenoid electrified →

Pressure reducing function

Control cover with pressure reducing function

(Dimensions in mm)

• Types ..DRW... (Nominal sizes 16 to 63)

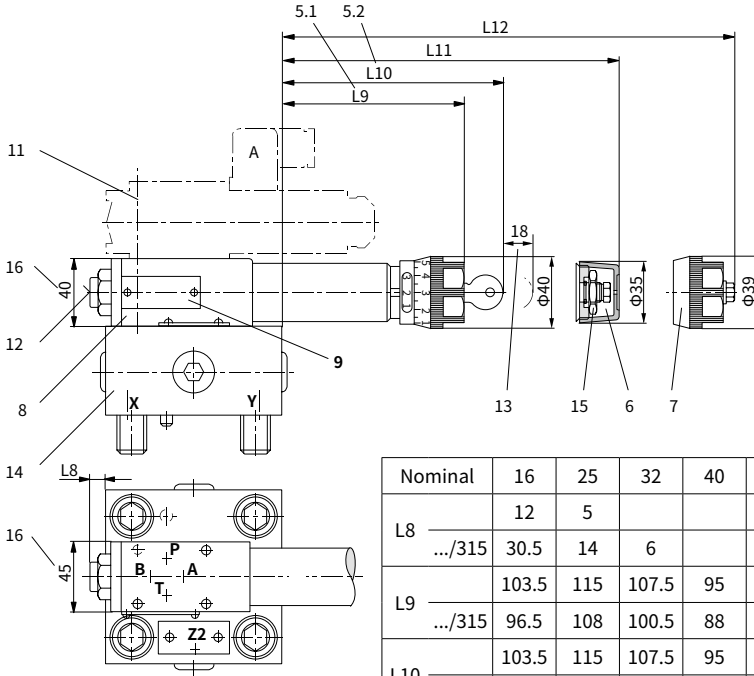

Nominal	16	25	32	40	50	63
L8	12	5				
.../315	30.5	14	6			
L9	103.5	115	107.5	95	87.5	71.5
.../315	96.5	108	100.5	88	80.5	64.5
L10	103.5	115	107.5	95	87.5	71.5
.../315	96.5	108	100.5	88	80.5	64.5
Other dimension	See Page "49/64"					

- 5.1 Adjustment element "4"
- 5.2 Adjustment element "3"
- 6 Adjustment element "2"
- 7 Adjustment element "1"
- 8 Direct operated pressure reducing valve
(is included within the scope of supply)
- 9 Pressure reducing valve name plate
- 11 Valve fixing screws
M5×90 GB/T 70.1-10.9 $M_A = 8.9$ Nm
are included within the control cover
scope of supply.
Solenoid directional valve 3WE6B9...
must be ordered separately

- 12 Pressure gauge port G1/4, 12 deep;
Socket screw A/F6
- 13 Space required to remove the key
- 14 Control cover
- 15 Locknut A/F24
- 16 For type .../315 → 50 mm

Control cover with pressure reducing function

· Types ..DREV...; ..DREZ...(Nominal sizes 25 to 63)

L-LFA		7X				
Nominal size 25	= 25	=DREV	=DREZ	No code =	NBR seals	
Nominal size 32	= 32				V =	FKM seals
Nominal size 40	= 40				(Other seals, please consult us!)	
Nominal size 50	= 50				Caution:	
Nominal size 63	= 63				The harmony of seals and fluid must be taken into account.	
Pressure reducing function; electrical-proportional		Pressure stages				
Pressure reducing function; electrical-prop. and possibility for 2-way flow control function		(pressure reducing valve)				
		006 = 7bar (only for DREV)				
		014 = 16bar (only for DREZ)				
Series 70 to 79 (70 to 79: unchanged installation and connection dimensions)		=7X				

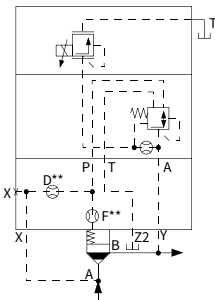

LFA..DREV-7X/006
NG 25, 32

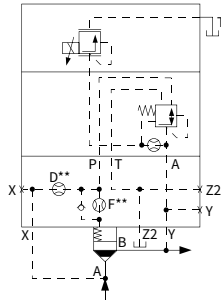

LFA..DREV-7X/006
NG 40, 50

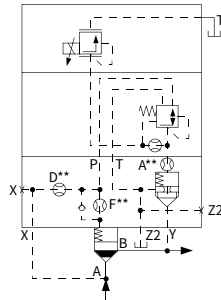

LFA..DREV-7X/006
NG 63

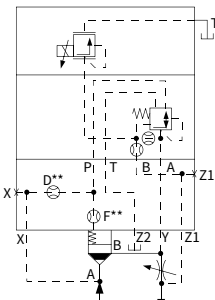

LFA..DREZ-7X/014
NG 25, 32

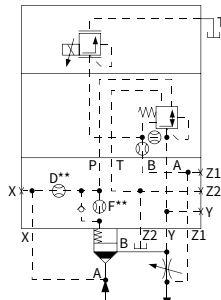

LFA..DREZ-7X/014
NG 40, 50

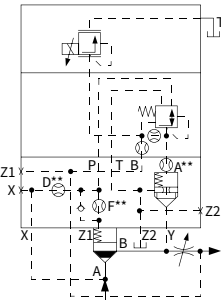

LFA..DREZ-7X/014
NG 63

Control cover with pressure reducing function

(Dimensions in mm)

• Types ..DREV...; ..DREZ...(Nominal sizes 25 to 63)

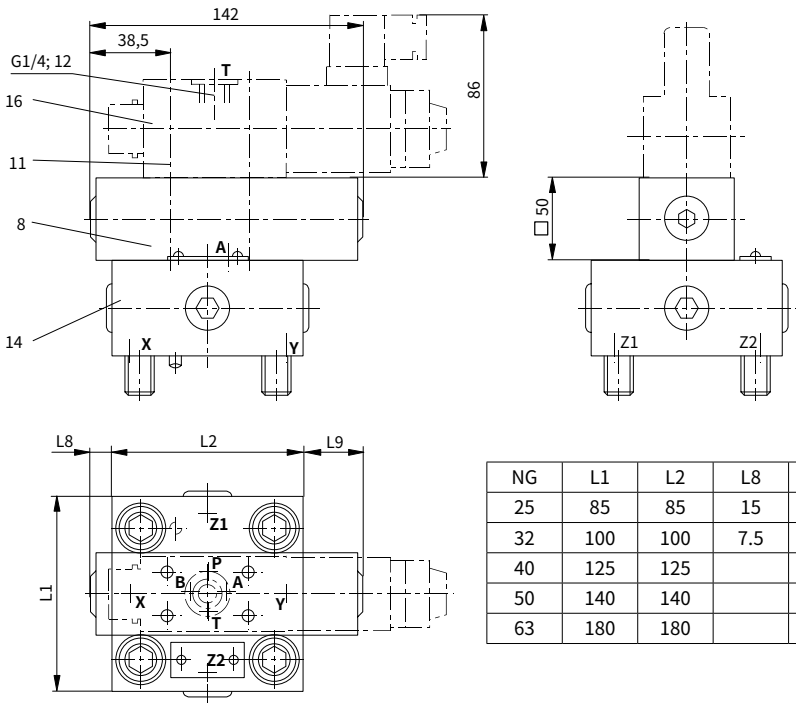

8 Pressure reducing valve (is included within the scope of supply)

11 Valve fixing screws: M5×100 GB/T 70.1-10.9 $M_A = 8.9$ Nm are included within the control cover scope of supply

14 Control cover, see page "49/64"

16 Proportional pressure relief valve, DBET-5X/...³⁾ Y G24-1⁴⁾ (must be ordered separately)

³⁾ Pressure stages for valve type: DBET-5X/...50, 100, 200, 315 and 350 bar

⁴⁾ 1 = G 1/4 threaded port T, special poppet

Control cover for pressure reducing functions and isolating functions; electrical-proportional

· Types ..DREWW...; ..DREWZ...(Nominal sizes 25 to 63)

L-LFA		- 7X /			
Nominal size 25	= 25				No code = NBR seals V = FKM seals (Other seals, please consult us!) Caution: The harmony of seals and fluid must be taken into account.
Nominal size 32	= 32				
Nominal size 40	= 40				
Nominal size 50	= 50				
Nominal size 63	= 63				
Pressure reducing function, electrical-proportional and isolating function	=DREWW				Pressure stages (pressure reducing valve) 006 = 7bar (only for DREWW) 014 = 16bar (only for DREWZ)
Pressure reducing function, electrical-prop. and isolating function, including possibility for 2-way flow control function	=DREWZ				
Series 70 to 79 (70 to 79: unchanged installation and connection dimensions)	=7X				

05

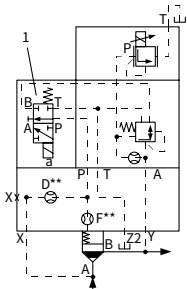

LFA..DREWW-7X/006
NG 25, 32

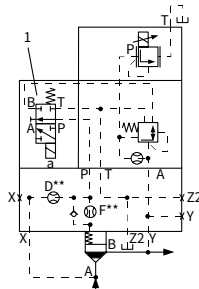

LFA..DREWW-7X/006
NG 40, 50

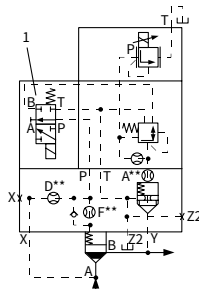

LFA..DREWW-7X/006
NG 63

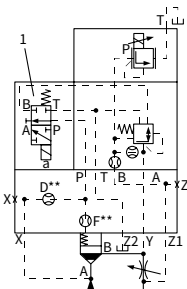

LFA..DREWZ-7X/014
NG 25, 32

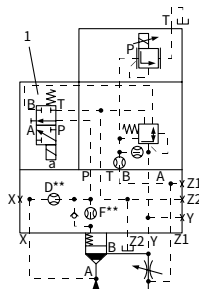

LFA..DREWZ-7X/014
NG 40, 50

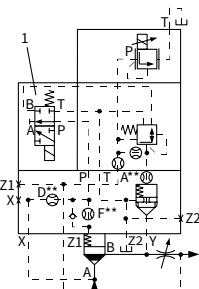

LFA..DREWZ-7X/014
NG 63

1 3WE 6 A-../.. Solenoid de-energized → closed
 Solenoid energized → pressure reducing function

Control cover for pressure reducing functions and isolating functions; electrical-proportional

• Types ..DREWV...; ..DREWZ...(Nominal sizes 25 to 63)

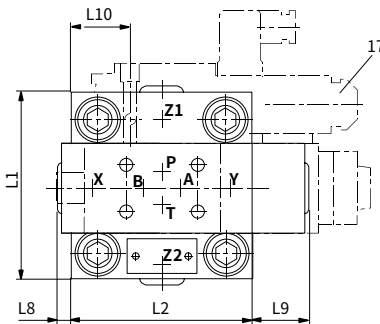
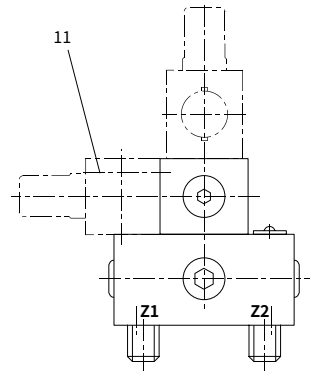
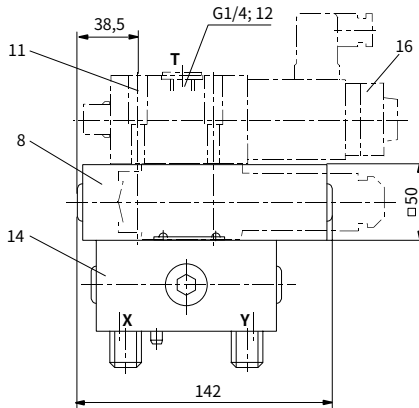

NG	L1	L2	L8	L9	L10
25	85	85	15	42	30
32	100	100	7.5	35	37.5
40	125	125		22	50
50	140	140		15	57.5
63	180	180			81.5

- 8 Pressure reducing valve (is included within the scope of supply)
- 11 Valve fixing screws: M5×100 GB/T 70.1-10.9 $M_A = 8.9 \text{ Nm}$ are included within the control cover scope of supply
- 14 Control cover, see page "49/64"
- 16 Proportional pressure relief valve: DBET-5X/...³⁾ Y G24-1⁴⁾ (must be ordered separately)
- 17 Directional spool valve 3WE 6 A... (must be ordered separately)

- ³⁾ Pressure stages for valve type: DBET-5X/...50, 100, 200, 315 and 350bar
- ⁴⁾ 1 = G 1/4 threaded port, special poppet

2-way cartridge valves -pressure control function

5.2-3

Pressure sequencing function

Control covers Type L-LFA.DZ...

Technical data

Fluid		Mineral oil suitable for NBR and FKM seal
		Phosphate ester for FKM seal
Fluid temperature range	°C	-30 to +80 (NBR seal)
		-20 to +80 (FKM seal)
Viscosity range	mm ² /s	2.8 to 380
Degree of contamination		Maximum permissible degree of fluid contamination: Class 9. NAS 1638 or 20/18/15, ISO4406 ¹⁾

For applications outside these parameters, please consult us)

¹⁾ To prevent the problem caused by fluid contamination, fluid cleanliness mentioned above must be met.

Technical data

Control cover			
Max. perm operating pressure im Anschluss...		Control cover type	
		LFA..DZ.-../...	LFA..DZW.-../...
		/....	/...Y
		/...X	/...XY
...X; ...Z2		315bar	
Y	When regulating the pressure	Zero pressure (up to 2bar)	
	Static	315 bar	210bar (=) ; 160bar (~)
Z1	When regulating the pressure	Zero pressure (up to 2bar)	
	Static	315 bar	210bar (=); 160bar (~) 315bar
Settable sequencing pressure		210bar, 315bar, 350bar	

O-rings dimensions for ports X, Y, Z1, Z2 (included within the scope of supply)

Size	Dimension mm
16	8×1.8
25	9.25×1.78

Size	Dimension mm
32	10.82×1.78
40, 50	12×2.5

05

Fixing screw (included within the scope of supply)

In accordance with GB/T70.1 10.9			
Nominal size	Quantity	Dimension	Tightening torque (Nm)
16	4	M8×115	32
25		M12×120	110
32		M16×120	270

In accordance with GB/T70.1 10.9			
Nominal size	Quantity	Dimension	Tightening torque (Nm)
40	4	M20×70	520
50		M20×80	520

Control cover for pressure sequencing functions

· Types ..DZ... (Nominal sizes 16 to 50)

	L-LFA		DZ	- 7X /			
Nominal size 16	= 16						
Nominal size 25	= 25						
Nominal size 32	= 32						
Nominal size 40	= 40						
Nominal size 50	= 50						
Adjustment type							
Rotary knob	= 1						
Hexagon with protective cap	= 2						
Lockable rotary knob with scale (H-key to automotive industry standards)	= 3						
Rotary knob with scale not lockable	= 4						
Series 70 to 79				= 7X			
(70 to 79: unchanged installation and connection dimensions)							

No code = NBR seals
 V = FKM seals
 (Other seals, please consult us!)

Caution:
 The harmony of seals and fluid must be taken into account.

Pilot oil supply		
	Pilot oil supply	Pilot oil drain
No code=	Internal	Internal
X =	External	Internal
Y =	Internal	External
XY =	External	External

Pressure stages (max. settable sequencing pressure)

210=	210 bar
315=	315 bar
350=	350 bar

05

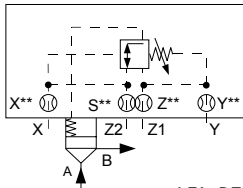

LFA..DZ.-../315
210
350

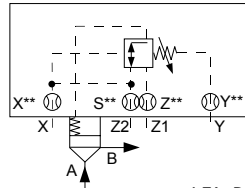

LFA..DZ.-../315Y
210
350

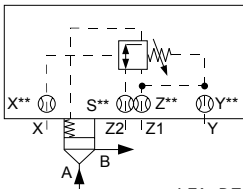

LFA..DZ.-../315X
210
350

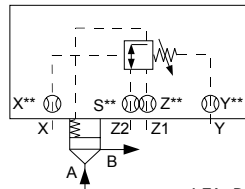

LFA..DZ.-../315XY
210
350

Control cover for pressure sequencing functions

(Dimensions in mm)

• Types ..DZ... (Nominal sizes 16 to 50)

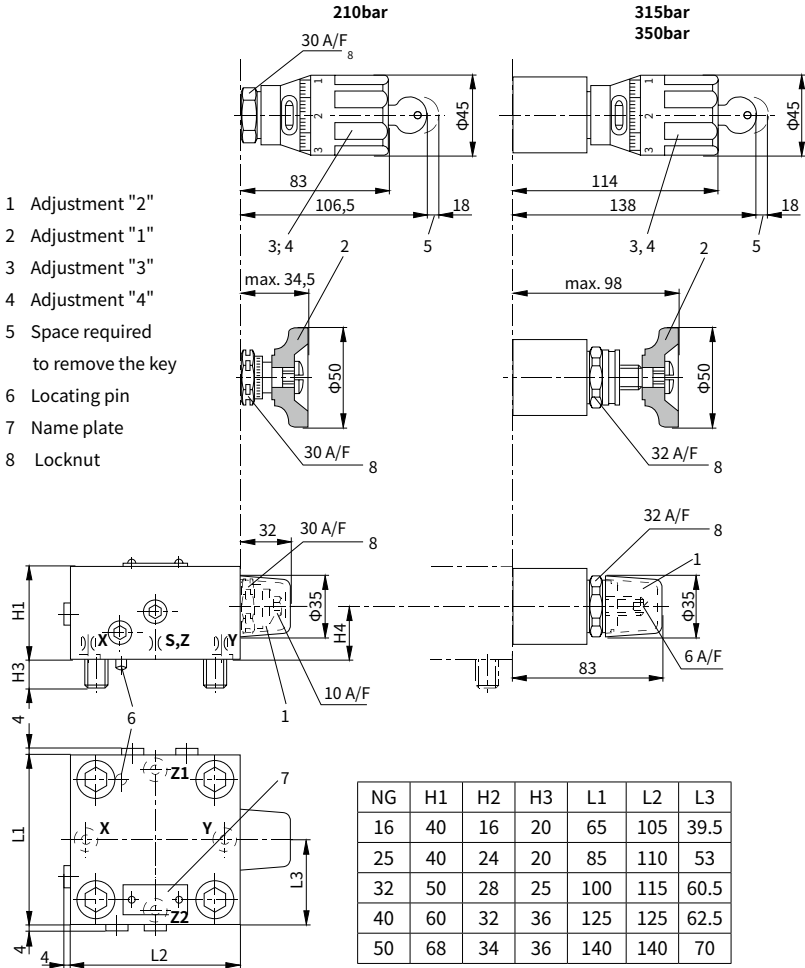

05

Control cover for pressure dependent and independent sequencing functions

· Types ..DZW... (Nominal sizes 16 to 50)

L-LFA				- 7X /			
-------	--	--	--	--------	--	--	--

Nominal size 16	= 16
Nominal size 25	= 25
Nominal size 32	= 32
Nominal size 40	= 40
Nominal size 50	= 50

No code = NBR seals
 V = FKM seals
 (Other seals, please consult us!)
Caution:
 The harmony of seals and fluid must be taken into account.

Solenoid de-energised:	
Pressure sequence function	=DZWA
Solenoid energised: Open	
Solenoid de-energised: Open	=DZWB
solenoid energised:	
Pressure sequence function	

Pilot oil supply		
	Pilot oil supply	Pilot oil drain
No code=	Internal	Internal
X =	External	Internal
Y =	Internal	External
XY =	External	External

Adjustment type	
Rotary knob	= 1
Hexagon with protective cap	= 2
Lockable rotary knob with scale	= 3
(H-key to automotive industry standards)	
Rotary knob with scale not lockable	= 4

Pressure stages (max. settable sequencing pressure)	
210=	210bar
315=	315bar
350=	350bar

7X= Series 70 to 79
 (70 to 79: unchanged installation and connection dimensions)

05

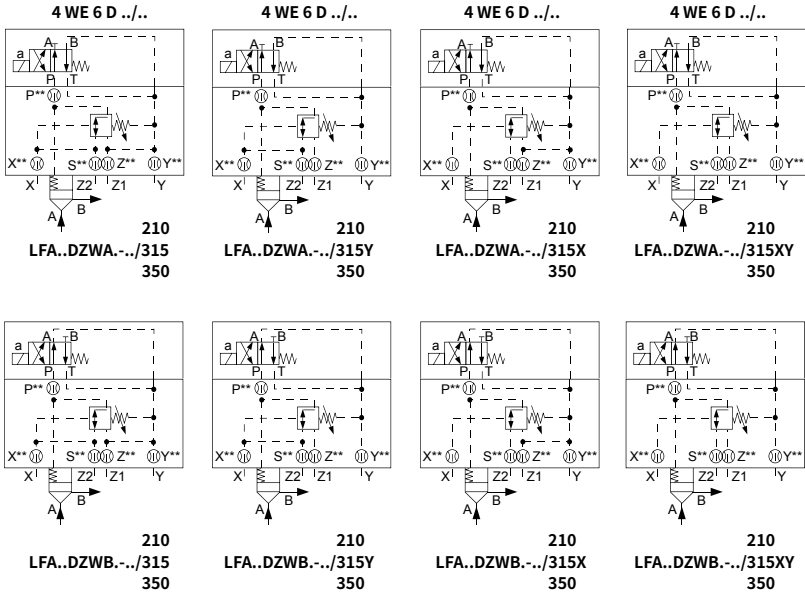

Control cover for pressure dependent and independent sequencing functions

• Types ..DZW... (Nominal sizes 16 to 50)

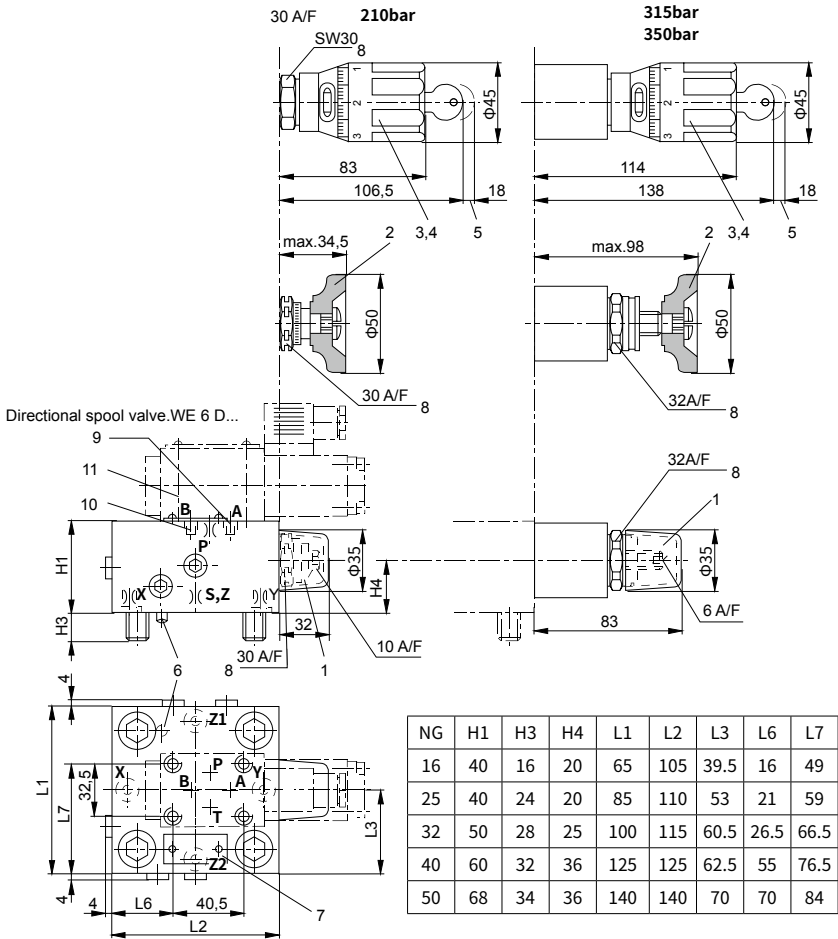

- 1 Adjustment "2"
- 2 Adjustment "1"
- 3 Adjustment "3"
- 4 Adjustment "4"
- 5 Space required to remove the key
- 6 Locating pin
- 7 Name plate

- 8 Locknut
- 9 Plug M6 tapered for DZWA..
- 10 Plug M6 tapered for DZWB..
- 11 Directional valve: WE6
GB/T70.1-M5×50-10.9 M_s=8.9Nm
Valve fixing screws are included
within the control cover scope of supply

China

+86 400 101 8889

America

+01 630 995 3674

Germany

+49 172 3683463

Japan

+81 03 6809 1696



© This brochure can be reproduced, edited, reproduced or transmitted electronically without the authorization of Hengli Hydraulic Company. Due to the continuous development of the product, the information in this brochure is not specific to the specific conditions or applicability of the industry, thus, Hengli does not take any responsibility for any incomplete or inaccurate description.